

When considering ceiling lighting, Recessed Lighting has become a very popular option. Used frequently in home remodels and in new home construction recessed lighting works great in almost any location in the home. Versatile and available in a multitude of sizes and lamp combinations recessed ceiling lighting is an affordable and attractive solution for whatever your application. Before buying be sure to read our blog to learn more about designing with recessed lighting and you will also want to read our article Recessed Lighting Tips and General Guidelines.

Sing Dei Enterprise Co., Ltd.   
the best for your illumination

### DOWN LIGHT

Recessed Lighting has become a very popular option

002

### SPOT LIGHT

Used frequently in home remodels

028

### BOX LIGHT

Versatile and available in a multitude of sizes and lamp

050

### SPOT BRACKET

recessed ceiling lighting is an affordable and attractive solution

059

### CEILING

Lighting Tips and General Guidelines

060

### BRACKET

attractive solution for whatever application

062

### PANDENT

Lighting has become a very popular option

068

### CEILING

more about designing with recessed

077

# DOWN LIGHT

High efficiency high energy-saving



CI-5002-1  
CI-5003-1



CI-5002-2  
CI-5003-2

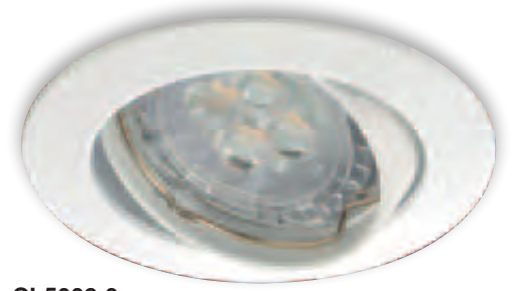

CI-5002-3  
CI-5003-3



## CI-5002-1 670

AC MR-16 6W 嵌燈  
尺寸：φ 95mm H55mm  
輸入電壓：90~240V  
光源：OSRAM inside  
流明：400lm  
嵌入孔：80mm  
材質：鋁材 拉絲銀

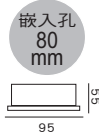

## CI-5002-2 570

AC MR-16 6W 嵌燈  
尺寸：φ 85mm H55mm  
輸入電壓：90~240V  
光源：OSRAM inside  
流明：400lm  
嵌入孔：75mm  
材質：鋁材 拉絲銀

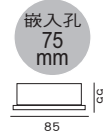

## CI-5002-3 510

AC MR-16 6W 嵌燈  
尺寸：φ 85mm H55mm  
輸入電壓：90~240V  
光源：OSRAM inside  
流明：400lm  
嵌入孔：75mm  
材質：鋁材 粉體烤漆

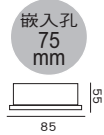

## CI-5003-1 750

DC MR-16 6W 嵌燈  
尺寸：φ 95mm H55mm  
輸入電壓：90~240V  
光源：NICHIA inside  
流明：400lm  
嵌入孔：80mm  
材質：鋁材 拉絲銀

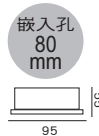

## CI-5003-2 650

DC MR-16 6W 嵌燈  
尺寸：φ 85mm H55mm  
輸入電壓：90~240V  
光源：NICHIA inside  
流明：400lm  
嵌入孔：75mm  
材質：鋁材 拉絲銀

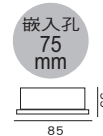

## CI-5003-3 580

DC MR-16 6W 嵌燈  
尺寸：φ 85mm H55mm  
輸入電壓：90~240V  
光源：NICHIA inside  
流明：400lm  
嵌入孔：75mm  
材質：鋁材 粉體烤漆

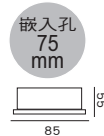

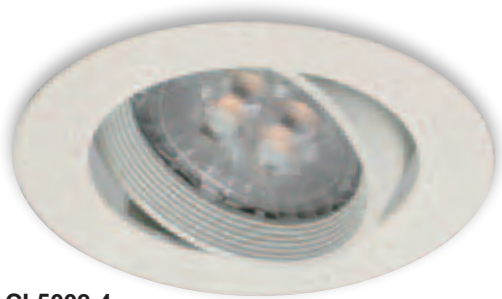

CI-5002-4  
CI-5003-4



CI-5002-5  
CI-5003-5



### SL-209-N



- 燈泡規格:MR-16 投射燈
- 消耗功率:6W
- LED: **NICHIA** Inside
- 輸入電壓:AC/DC 12V
- 輸出流明:400lm  
(取代 75W 鎢絲燈泡)
- 顏色:W/WW
- 演色性 CRI:84
- 出光角度:25° 45°
- 工作壽命:30,000 小時
- 需使用於開放性空間
- 材質:鋁鍍片
- 尺寸(mm):φ 49\*41

### SL-209-AC

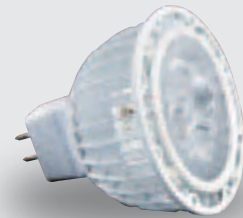

- 燈泡規格:MR-16 投射燈
- 消耗功率:6W
- LED: **OSRAM** Inside
- 輸入電壓:90-240V
- 輸出流明:400lm  
(取代 75W 鎢絲燈泡)
- 顏色:W/WW
- 演色性 CRI:84
- 出光角度:25° 45°
- 工作壽命:30,000 小時
- 需使用於開放性空間
- 材質:鋁鍍片
- 尺寸(mm):φ 49\*41

#### CI-5002-4 800

AC MR-16 6W 嵌燈  
尺寸: φ 82mm H55mm  
輸入電壓: 90-240V  
光源: **OSRAM** inside  
流明: 400lm  
嵌入孔: 75mm  
材質: 鋁製品 粉體烤漆

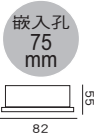

#### CI-5002-5 570

AC MR-16 6W 嵌燈  
尺寸: φ 85mm H55mm  
輸入電壓: 90-240V  
光源: **OSRAM** inside  
流明: 400lm  
嵌入孔: 75mm  
材質: 鋁材 粉體烤漆

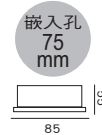

#### CI-5003-4 880

DC MR-16 6W 嵌燈  
尺寸: φ 82mm H55mm  
輸入電壓: 90-240V  
光源: **NICHIA** inside  
流明: 400lm  
嵌入孔: 75mm  
材質: 鋁製品 粉體烤漆

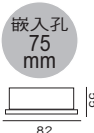

#### CI-5003-5 650

DC MR-16 6W 嵌燈  
尺寸: φ 85mm H55mm  
輸入電壓: 90-240V  
光源: **NICHIA** inside  
流明: 400lm  
嵌入孔: 75mm  
材質: 鋁材 粉體烤漆

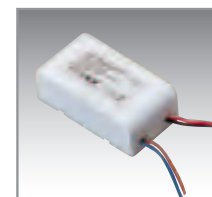
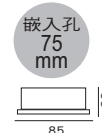

DC MR-16 LED  
專用電源

# DOWN LIGHT

High efficiency high energy-saving



CI-5004-1  
CI-5005-1



CI-5004-2  
CI-5005-2

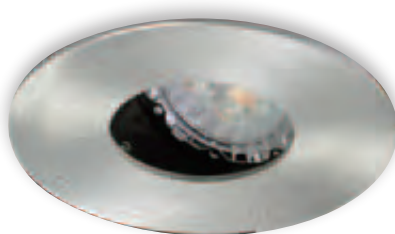

CI-5004-3  
CI-5005-3



CI-5004-4  
CI-5005-4



## CI-5004-1 510

AC MR-16 6W 嵌燈  
尺寸：φ 95mm H55mm  
輸入電壓：90~240V  
光源：**OSRAM** inside  
流明：400lm  
嵌入孔：80mm  
材質：鋁材 粉體烤漆

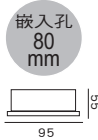

## CI-5004-2 670

AC MR-16 6W 嵌燈  
尺寸：φ 87mm H70mm  
輸入電壓：90~240V  
光源：**OSRAM** inside  
流明：400lm  
嵌入孔：75mm  
材質：鋁製品 粉體烤漆

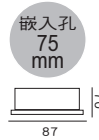

## CI-5004-3 870

AC MR-16 6W 嵌燈  
尺寸：φ 85mm H80mm  
輸入電壓：90~240V  
光源：**OSRAM** inside  
流明：400lm  
嵌入孔：75mm  
材質：鋁材 拉絲銀

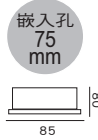

## CI-5004-4 670

AC MR-16 6W 嵌燈  
尺寸：φ 87mm H70mm  
輸入電壓：90~240V  
光源：**OSRAM** inside  
流明：400lm  
嵌入孔：75mm  
材質：鋁製品 粉體烤漆

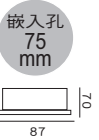

## CI-5005-1 580

DC MR-16 6W 嵌燈  
尺寸：φ 95mm H55mm  
輸入電壓：90~240V  
光源：**NICHIA** inside  
流明：400lm  
嵌入孔：80mm  
材質：鋁材 粉體烤漆



## CI-5005-2 750

DC MR-16 6W 嵌燈  
尺寸：φ 87mm H70mm  
輸入電壓：90~240V  
光源：**NICHIA** inside  
流明：400lm  
嵌入孔：75mm  
材質：鋁製品 粉體烤漆



## CI-5005-3 940

DC MR-16 6W 嵌燈  
尺寸：φ 85mm H80mm  
輸入電壓：90~240V  
光源：**NICHIA** inside  
流明：400lm  
嵌入孔：75mm  
材質：鋁材 拉絲銀

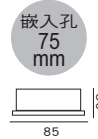

## CI-5005-4 750

DC MR-16 6W 嵌燈  
尺寸：φ 87mm H70mm  
輸入電壓：90~240V  
光源：**NICHIA** inside  
流明：400lm  
嵌入孔：75mm  
材質：鋁製品 粉體烤漆

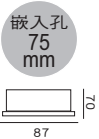



CI-5004-5  
CI-5005-5



CI-5004-6  
CI-5005-6



CI-5004-7  
CI-5005-7



CI-5004-8  
CI-5005-8



SL-209-N

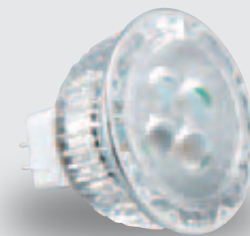

SL-209-AC

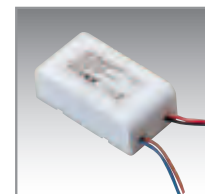
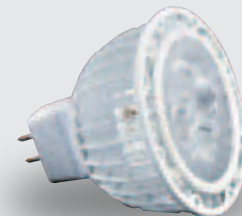

DC MR-16 LED  
專用電源

**CI-5004-5 440**

AC MR-16 6W 嵌燈  
尺寸：φ 85mm H55mm  
輸入電壓：90~240V  
光源：**OSRAM** inside  
流明：400lm  
嵌入孔：65mm  
材質：鐵材 粉體烤漆

嵌入孔  
65  
mm



**CI-5004-6 1,030**

AC MR-16 6W 嵌燈  
尺寸：φ 110mm H65mm  
輸入電壓：90~240V  
光源：**OSRAM** inside  
流明：400lm  
嵌入孔：95mm  
材質：鋁材 粉體烤漆

嵌入孔  
95  
mm



**CI-5004-7 640**

AC MR-16 6W 嵌燈  
尺寸：φ 85mm H80mm  
輸入電壓：90~240V  
光源：**OSRAM** inside  
流明：400lm  
嵌入孔：65mm  
材質：鐵製品 電鍍銀

嵌入孔  
65  
mm



**CI-5004-8 480**

AC MR-16 6W 嵌燈  
尺寸：φ 85mm H55mm  
輸入電壓：90~240V  
光源：**OSRAM** inside  
流明：400lm  
嵌入孔：65mm  
材質：鐵材 電鍍銀

嵌入孔  
65  
mm



**CI-5004-5 520**

DC MR-16 6W 嵌燈  
尺寸：φ 85mm H55mm  
輸入電壓：90~240V  
光源：**NICHIA** inside  
流明：400lm  
嵌入孔：65mm  
材質：鐵材 粉體烤漆

嵌入孔  
65  
mm



**CI-5004-6 1,100**

DC MR-16 6W 嵌燈  
尺寸：φ 110mm H65mm  
輸入電壓：90~240V  
光源：**NICHIA** inside  
流明：400lm  
嵌入孔：95mm  
材質：鋁材 粉體烤漆

嵌入孔  
95  
mm



**CI-5004-7 710**

DC MR-16 6W 嵌燈  
尺寸：φ 85mm H80mm  
輸入電壓：90~240V  
光源：**NICHIA** inside  
流明：400lm  
嵌入孔：65mm  
材質：鐵製品 電鍍銀

嵌入孔  
65  
mm



**CI-5004-8 550**

DC MR-16 6W 嵌燈  
尺寸：φ 85mm H55mm  
輸入電壓：90~240V  
光源：**NICHIA** inside  
流明：400lm  
嵌入孔：65mm  
材質：鐵材 電鍍銀

嵌入孔  
65  
mm



# DOWN LIGHT

High efficiency high energy-saving



CI-5006-1  
CI-5007-1

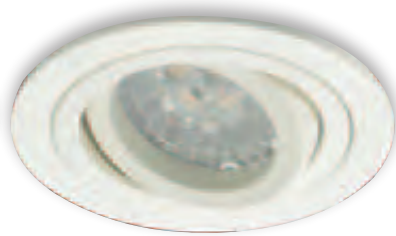

CI-5006-2  
CI-5007-2



CI-5006-3  
CI-5007-3



CI-5006-4  
CI-5007-4



## CI-5006-1 670

AC MR-16 6W 嵌燈  
尺寸：φ 95mm H80mm  
輸入電壓：90~240V  
光源：**OSRAM** inside  
流明：400lm  
嵌入孔：80mm  
材質：鋁材 粉體烤漆

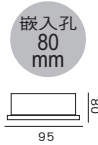

## CI-5006-2 610

AC MR-16 6W 嵌燈  
尺寸：φ 90mm H55mm  
輸入電壓：90~240V  
光源：**OSRAM** inside  
流明：400lm  
嵌入孔：80mm  
材質：鋁材 粉體烤漆

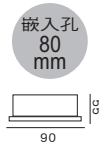

## CI-5006-3 670

AC MR-16 6W 嵌燈  
尺寸：φ 90mm H55mm  
輸入電壓：90~240V  
光源：**OSRAM** inside  
流明：400lm  
嵌入孔：80mm  
材質：鋁材 拉絲銀

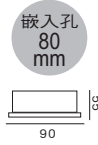

## CI-5006-4 1,090

AC MR-16 6W 嵌燈  
尺寸：φ 90mm H75mm  
輸入電壓：90~240V  
光源：**OSRAM** inside  
流明：400lm  
嵌入孔：80mm  
材質：鋁製品 粉體烤漆

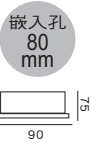

## CI-5007-1 750

DC MR-16 6W 嵌燈  
尺寸：φ 95mm H80mm  
輸入電壓：90~240V  
光源：**NICHIA** inside  
流明：400lm  
嵌入孔：80mm  
材質：鋁材 粉體烤漆

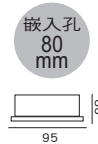

## CI-5007-2 680

DC MR-16 6W 嵌燈  
尺寸：φ 90mm H55mm  
輸入電壓：90~240V  
光源：**NICHIA** inside  
流明：400lm  
嵌入孔：80mm  
材質：鋁材 粉體烤漆

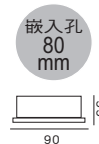

## CI-5007-3 750

DC MR-16 6W 嵌燈  
尺寸：φ 90mm H55mm  
輸入電壓：90~240V  
光源：**NICHIA** inside  
流明：400lm  
嵌入孔：80mm  
材質：鋁材 拉絲銀

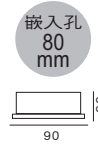

## CI-5007-4 1,170

DC MR-16 6W 嵌燈  
尺寸：φ 90mm H75mm  
輸入電壓：90~240V  
光源：**NICHIA** inside  
流明：400lm  
嵌入孔：80mm  
材質：鋁製品 粉體烤漆

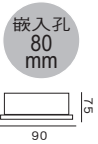



CI-5006-5  
CI-5007-5



CI-5006-6  
CI-5007-6



CI-5006-7  
CI-5007-7



CI-5006-8  
CI-5007-8



SL-209-N



SL-209-AC

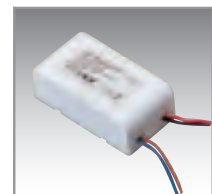
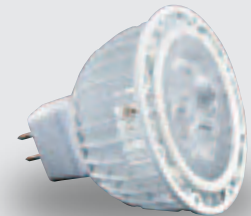

DC MR-16 LED  
專用電源

**CI-5006-5 610**

AC MR-16 6W 嵌燈  
尺寸：φ 95mm H55mm  
輸入電壓：90~240V  
光源：**OSRAM** inside  
流明：400lm  
嵌入孔：80mm  
材質：鋁材 粉體烤漆

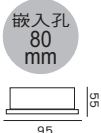

**CI-5006-6 1,160**

AC MR-16 6W 嵌燈  
尺寸：φ 90mm H50mm  
輸入電壓：90~240V  
光源：**OSRAM** inside  
流明：400lm  
嵌入孔：80mm  
材質：鋁材 粉體烤漆

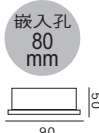

**CI-5006-7 670**

AC MR-16 6W 嵌燈  
尺寸：φ 90mm H55mm  
輸入電壓：90~240V  
光源：**OSRAM** inside  
流明：400lm  
嵌入孔：80mm  
材質：鋁材 粉體烤漆

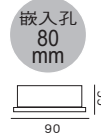

**CI-5006-8 770**

AC MR-16 6W 嵌燈  
尺寸：φ 95mm H80mm  
輸入電壓：90~240V  
光源：**OSRAM** inside  
流明：400lm  
嵌入孔：80mm  
材質：鋁材 粉體烤漆

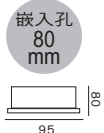

**CI-5007-5 680**

DC MR-16 6W 嵌燈  
尺寸：φ 95mm H55mm  
輸入電壓：90~240V  
光源：**NICHIA** inside  
流明：400lm  
嵌入孔：80mm  
材質：鋁材 粉體烤漆

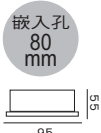

**CI-5007-6 1,230**

DC MR-16 6W 嵌燈  
尺寸：φ 90mm H50mm  
輸入電壓：90~240V  
光源：**NICHIA** inside  
流明：400lm  
嵌入孔：80mm  
材質：鋁材 粉體烤漆

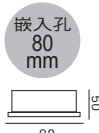

**CI-5007-7 750**

DC MR-16 6W 嵌燈  
尺寸：φ 90mm H55mm  
輸入電壓：90~240V  
光源：**NICHIA** inside  
流明：400lm  
嵌入孔：80mm  
材質：鋁材 粉體烤漆

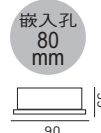

**CI-5007-8 840**

DC MR-16 6W 嵌燈  
尺寸：φ 95mm H80mm  
輸入電壓：90~240V  
光源：**NICHIA** inside  
流明：400lm  
嵌入孔：80mm  
材質：鋁材 粉體烤漆

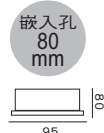

# DOWN LIGHT

High efficiency high energy-saving



CI-5008-1  
CI-5009-1

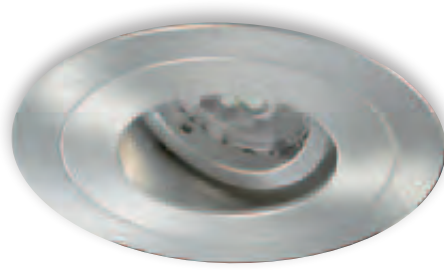

CI-5008-2  
CI-5009-2



CI-5008-3  
CI-5009-3



**CI-5008-1 1,090**  
AC MR-16 6W 嵌燈  
尺寸：φ 90mm H70mm  
輸入電壓：90~240V  
光源：**OSRAM** inside  
流明：400lm  
嵌入孔：80mm  
材質：鋁材 拉絲銀

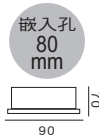

**CI-5008-2 1,090**  
AC MR-16 6W 嵌燈  
尺寸：φ 90mm H70mm  
輸入電壓：90~240V  
光源：**OSRAM** inside  
流明：400lm  
嵌入孔：80mm  
材質：鋁材 拉絲銀

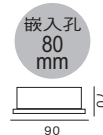

**CI-5008-3 1,190**  
AC MR-16 6W 嵌燈  
尺寸：φ 90mm H75mm  
輸入電壓：90~240V  
光源：**OSRAM** inside  
流明：400lm  
嵌入孔：80mm  
材質：鋁材 粉體烤漆

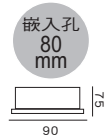

**CI-5009-1 1,170**  
DC MR-16 6W 嵌燈  
尺寸：φ 90mm H70mm  
輸入電壓：90~240V  
光源：**NICHIA** inside  
流明：400lm  
嵌入孔：80mm  
材質：鋁材 拉絲銀

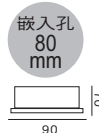

**CI-5009-2 1,170**  
DC MR-16 6W 嵌燈  
尺寸：φ 90mm H70mm  
輸入電壓：90~240V  
光源：**NICHIA** inside  
流明：400lm  
嵌入孔：80mm  
材質：鋁材 拉絲銀

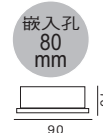

**CI-5009-3 1,270**  
DC MR-16 6W 嵌燈  
尺寸：φ 90mm H75mm  
輸入電壓：90~240V  
光源：**NICHIA** inside  
流明：400lm  
嵌入孔：80mm  
材質：鋁材 粉體烤漆

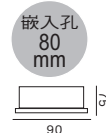



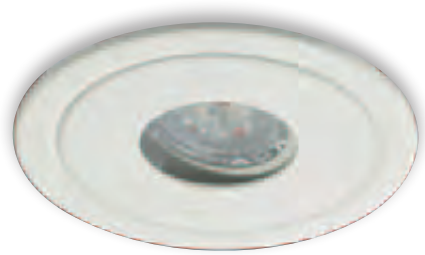

CI-5008-4  
CI-5009-4



CI-5008-5  
CI-5009-5



CI-5008-6  
CI-5009-6



SL-209-N



SL-209-AC

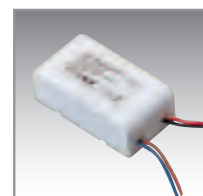

DC MR-16 LED  
專用電源

**CI-5008-4 640**

AC MR-16 6W 嵌燈  
尺寸：φ110mm H65mm  
輸入電壓：90-240V  
光源：**OSRAM** inside  
流明：400lm  
嵌入孔：90mm  
材質：鐵材 粉體烤漆

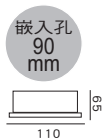

**CI-5008-5 870**

AC MR-16 6W 嵌燈  
尺寸：φ111mm H110mm  
輸入電壓：90-240V  
光源：**OSRAM** inside  
流明：400lm  
嵌入孔：97mm  
材質：鋁材 粉體烤漆

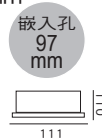

**CI-5008-6 900**

AC MR-16 6W 嵌燈  
尺寸：φ111mm H110mm  
輸入電壓：90-240V  
光源：**OSRAM** inside  
流明：400lm  
嵌入孔：97mm  
材質：鋁材 粉體烤漆

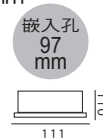

**CI-5009-4 710**

DC MR-16 6W 嵌燈  
尺寸：φ110mm H65mm  
輸入電壓：90-240V  
光源：**NICHIA** inside  
流明：400lm  
嵌入孔：90mm  
材質：鐵材 粉體烤漆

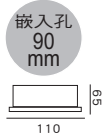

**CI-5009-5 940**

DC MR-16 6W 嵌燈  
尺寸：φ111mm H110mm  
輸入電壓：90-240V  
光源：**NICHIA** inside  
流明：400lm  
嵌入孔：97mm  
材質：鋁材 粉體烤漆

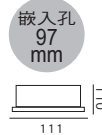

**CI-5009-6 970**

DC MR-16 6W 嵌燈  
尺寸：φ111mm H110mm  
輸入電壓：90-240V  
光源：**NICHIA** inside  
流明：400lm  
嵌入孔：97mm  
材質：鋁材 粉體烤漆

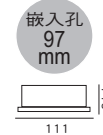

# DOWN LIGHT

High efficiency high energy-saving



CI-5010-1  
CI-5011-1



CI-5010-2  
CI-5011-2



CI-5010-3  
CI-5011-3



## CI-5010-1 1,290

AC MR-16 6W 嵌燈  
尺寸：φ 90mm H58mm  
輸入電壓：90~240V  
光源：**OSRAM** inside  
流明：400lm  
嵌入孔：80mm  
材質：全鋁 CNC 加工成型

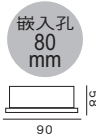

## CI-5010-2 1,260

AC MR-16 6W 嵌燈  
尺寸：φ 90mm H58mm  
輸入電壓：90~240V  
光源：**OSRAM** inside  
流明：400lm  
嵌入孔：80mm  
材質：鋁製品 粉體烤漆



## CI-5010-3 700

AC MR-16 6W 嵌燈  
尺寸：φ 110mm H65mm  
輸入電壓：90~240V  
光源：**OSRAM** inside  
流明：400lm  
嵌入孔：90mm  
材質：鋁製品 粉體烤漆

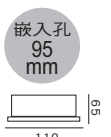

## CI-5011-1 1,360

DC MR-16 6W 嵌燈  
尺寸：φ 90mm H58mm  
輸入電壓：90~240V  
光源：**NICHIA** inside  
流明：400lm  
嵌入孔：80mm  
材質：全鋁 CNC 加工成型

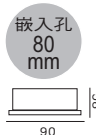

## CI-5011-2 1,330

DC MR-16 6W 嵌燈  
尺寸：φ 90mm H58mm  
輸入電壓：90~240V  
光源：**NICHIA** inside  
流明：400lm  
嵌入孔：80mm  
材質：鋁製品 粉體烤漆



## CI-5011-3 780

DC MR-16 6W 嵌燈  
尺寸：φ 110mm H65mm  
輸入電壓：90~240V  
光源：**NICHIA** inside  
流明：400lm  
嵌入孔：90mm  
材質：鋁製品 粉體烤漆

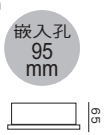



CI-5010-4  
CI-5011-4

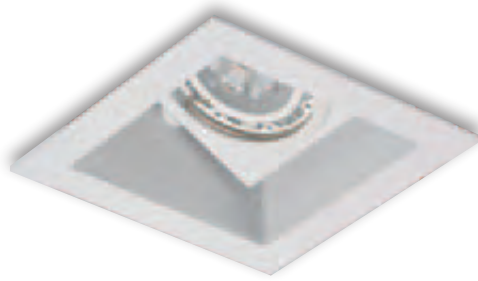

CI-5010-5  
CI-5011-5



CI-5010-6  
CI-5011-6



SL-209-N



SL-209-AC

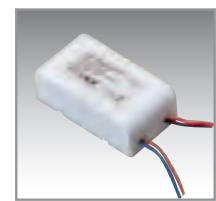
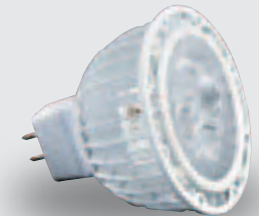

DC MR-16 LED  
專用電源

**CI-5010-4 800**

AC MR-16 6W 嵌燈  
尺寸：φ 80mm H70mm  
輸入電壓：90~240V  
光源：**OSRAM** inside  
流明：400lm  
嵌入孔：95mm  
材質：鋁製品 粉體烤漆



**CI-5010-5 740**

AC MR-16 6W 嵌燈  
尺寸：□ 97mm H75mm  
輸入電壓：90~240V  
光源：**OSRAM** inside  
流明：400lm  
嵌入孔：80×80mm  
材質：鋁製品 粉體烤漆

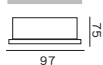

**CI-5010-6 700**

AC MR-16 6W 嵌燈  
尺寸：φ 84mm H55mm  
輸入電壓：90~240V  
光源：**OSRAM** inside  
流明：400lm  
嵌入孔：75mm  
材質：鋁製品 電鍍



**CI-5011-4 880**

DC MR-16 6W 嵌燈  
尺寸：φ 80mm H70mm  
輸入電壓：90~240V  
光源：**NICHIA** inside  
流明：400lm  
嵌入孔：70mm  
材質：鋁製品 粉體烤漆



**CI-5011-5 810**

DC MR-16 6W 嵌燈  
尺寸：□ 97mm H75mm  
輸入電壓：90~240V  
光源：**NICHIA** inside  
流明：400lm  
嵌入孔：80×80mm  
材質：鋁製品 粉體烤漆

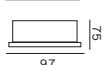

**CI-5011-6 780**

DC MR-16 6W 嵌燈  
尺寸：φ 84mm H55mm  
輸入電壓：90~240V  
光源：**NICHIA** inside  
流明：400lm  
嵌入孔：75mm  
材質：鋁製品 電鍍



# DOWN LIGHT

High efficiency high energy-saving



CI-5012-1  
CI-5013-1

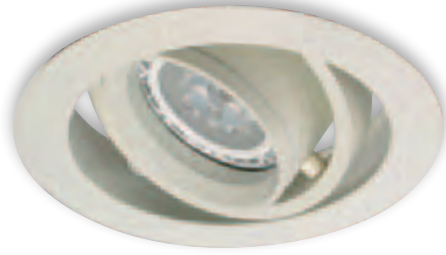

CI-5012-2  
CI-5013-2



CI-5012-3  
CI-5013-3



## CI-5012-1 1,090

AC MR-16 6W 嵌燈  
尺寸：φ 110mm H65mm  
輸入電壓：90~240V  
光源：**OSRAM** inside  
流明：400lm  
嵌入孔：95mm  
材質：鋁材 粉體烤漆

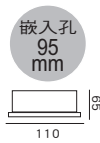

## CI-5012-2 1,030

AC MR-16 6W 嵌燈  
尺寸：φ 105mm H60mm  
輸入電壓：90~240V  
光源：**OSRAM** inside  
流明：400lm  
嵌入孔：95mm  
材質：鋁材 粉體烤漆

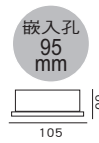

## CI-5012-3 640

AC MR-16 6W 嵌燈  
尺寸：φ 105mm H55mm  
輸入電壓：90~240V  
光源：**OSRAM** inside  
流明：400lm  
嵌入孔：93mm  
材質：鋁材 電鍍

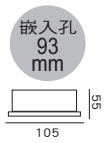

## CI-5013-1 1,170

DC MR-16 6W 嵌燈  
尺寸：φ 110mm H65mm  
輸入電壓：90~240V  
光源：**NICHIA** inside  
流明：400lm  
嵌入孔：95mm  
材質：鋁材 粉體烤漆

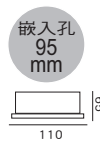

## CI-5013-2 1,100

DC MR-16 6W 嵌燈  
尺寸：φ 105mm H60mm  
輸入電壓：90~240V  
光源：**NICHIA** inside  
流明：400lm  
嵌入孔：95mm  
材質：鋁材 粉體烤漆

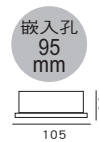

## CI-5013-3 710

DC MR-16 6W 嵌燈  
尺寸：φ 105mm H55mm  
輸入電壓：90~240V  
光源：**NICHIA** inside  
流明：400lm  
嵌入孔：93mm  
材質：鋁材 電鍍

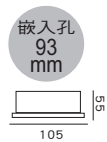



CI-5012-4  
CI-5013-4



CI-5012-5  
CI-5013-5



CI-5012-6  
CI-5013-6



SL-209-N



SL-209-AC

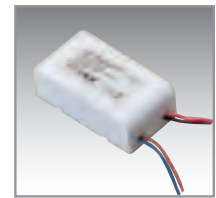
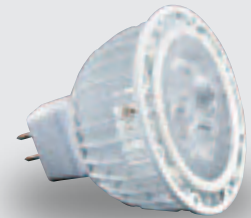

DC MR-16 LED  
專用電源

**CI-5012-4 490**

AC MR-16 6W 嵌燈  
尺寸：φ 105mm H55mm  
輸入電壓：90~240V  
光源：**OSRAM** inside  
流明：400lm  
嵌入孔：93mm  
材質：鋁材 粉體烤漆

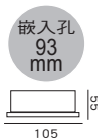

**CI-5012-5 560**

AC MR-16 6W 嵌燈  
尺寸：φ 105mm H55mm  
輸入電壓：90~240V  
光源：**OSRAM** inside  
流明：400lm  
嵌入孔：93mm  
材質：鋁材 粉體烤漆

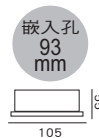

**CI-5012-6 530**

AC MR-16 6W 嵌燈  
尺寸：φ 105mm H55mm  
輸入電壓：90~240V  
光源：**OSRAM** inside  
流明：400lm  
嵌入孔：93mm  
材質：鋁材 粉體烤漆

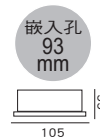

**CI-5013-4 570**

DC MR-16 6W 嵌燈  
尺寸：φ 105mm H55mm  
輸入電壓：90~240V  
光源：**NICHIA** inside  
流明：400lm  
嵌入孔：93mm  
材質：鋁材 粉體烤漆

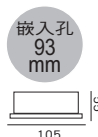

**CI-5013-5 630**

DC MR-16 6W 嵌燈  
尺寸：φ 105mm H55mm  
輸入電壓：90~240V  
光源：**NICHIA** inside  
流明：400lm  
嵌入孔：93mm  
材質：鋁材 粉體烤漆



**CI-5013-6 600**

DC MR-16 6W 嵌燈  
尺寸：φ 105mm H55mm  
輸入電壓：90~240V  
光源：**NICHIA** inside  
流明：400lm  
嵌入孔：93mm  
材質：鋁材 粉體烤漆

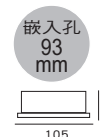

# DOWN LIGHT

High efficiency high energy-saving



CI-5014-1  
CI-5015-1



CI-5014-2  
CI-5015-2



CI-5014-3  
CI-5015-3



**CI-5014-1 1,190**  
AC MR-16 6W 嵌燈  
尺寸：φ 110mm H75mm  
輸入電壓：90~240V  
光源：**OSRAM** inside  
流明：400lm  
嵌入孔：95mm  
材質：鋁材 粉體烤漆

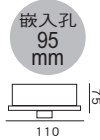

**CI-5014-2 900**  
AC MR-16 6W 嵌燈  
尺寸：φ 120mm H70mm  
輸入電壓：90~240V  
光源：**OSRAM** inside  
流明：400lm  
嵌入孔：105mm  
材質：鋁材 粉體烤漆



**CI-5014-3 640**  
AC MR-16 6W 嵌燈  
尺寸：φ 110mm H65mm  
輸入電壓：90~240V  
光源：**OSRAM** inside  
流明：400lm  
嵌入孔：95mm  
材質：鐵材 粉體烤漆

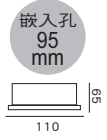

**CI-5015-1 1,270**  
DC MR-16 6W 嵌燈  
尺寸：φ 110mm H75mm  
輸入電壓：90~240V  
光源：**NICHIA** inside  
流明：400lm  
嵌入孔：95mm  
材質：鋁材 粉體烤漆

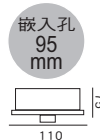

**CI-5015-2 970**  
DC MR-16 6W 嵌燈  
尺寸：φ 120mm H70mm  
輸入電壓：90~240V  
光源：**NICHIA** inside  
流明：400lm  
嵌入孔：105mm  
材質：鋁材 粉體烤漆

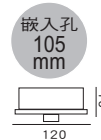

**CI-5015-3 710**  
DC MR-16 6W 嵌燈  
尺寸：φ 110mm H65mm  
輸入電壓：90~240V  
光源：**NICHIA** inside  
流明：400lm  
嵌入孔：95mm  
材質：鐵材 粉體烤漆

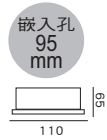



CI-5014-4  
CI-5015-4



CI-5014-5  
CI-5015-5



CI-5014-6  
CI-5015-6



SL-209-N



SL-209-AC

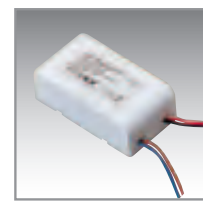
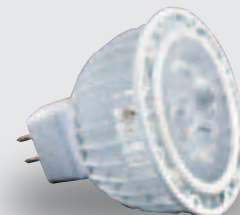

DC MR-16 LED  
專用電源

**CI-5014-4 900**

AC MR-16 6W 嵌燈  
尺寸：φ 110mm H70mm  
輸入電壓：90~240V  
光源：**OSRAM** inside  
流明：400lm  
嵌入孔：95mm  
材質：鋁材 粉體烤漆

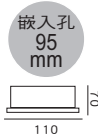

**CI-5014-5 770**

AC MR-16 6W 嵌燈  
尺寸：φ 125mm H80mm  
輸入電壓：90~240V  
光源：**OSRAM** inside  
流明：400lm  
嵌入孔：115mm  
材質：鋁材 粉體烤漆



**CI-5014-6 560**

AC MR-16 6W 嵌燈  
尺寸：φ 105mm H55mm  
輸入電壓：90~240V  
光源：**OSRAM** inside  
流明：400lm  
嵌入孔：93mm  
材質：鋁材 粉體烤漆

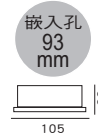

**CI-5015-4 970**

DC MR-16 6W 嵌燈  
尺寸：φ 110mm H70mm  
輸入電壓：90~240V  
光源：**NICHIA** inside  
流明：400lm  
嵌入孔：95mm  
材質：鋁材 粉體烤漆

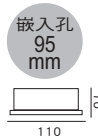

**CI-5015-5 840**

DC MR-16 6W 嵌燈  
尺寸：φ 125mm H80mm  
輸入電壓：90~240V  
光源：**NICHIA** inside  
流明：400lm  
嵌入孔：115mm  
材質：鋁材 粉體烤漆

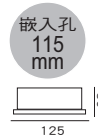

**CI-5015-6 630**

DC MR-16 6W 嵌燈  
尺寸：φ 105mm H55mm  
輸入電壓：90~240V  
光源：**NICHIA** inside  
流明：400lm  
嵌入孔：93mm  
材質：鋁材 粉體烤漆

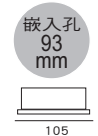

# DOWN LIGHT

High efficiency high energy-saving



**CI-5016-1 2,100**

COB 12W 嵌燈  
尺寸：φ 140mm H80mm  
輸入電壓：90~240V  
光源：CREE inside  
流明：1000lm  
嵌入孔：120mm  
材質：鋁製品 電鍍

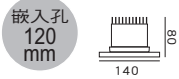

**CI-5016-2 2,100**

COB 12W 嵌燈  
尺寸：φ 140mm H80mm  
輸入電壓：90~240V  
光源：CREE inside  
流明：1000lm  
嵌入孔：120mm  
材質：鋁製品 電鍍

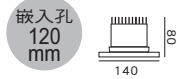

**CI-5016-3 2,100**

COB 12W 嵌燈  
尺寸：φ 140mm H80mm  
輸入電壓：90~240V  
光源：CREE inside  
流明：1000lm  
嵌入孔：120mm  
材質：鋁製品 電鍍

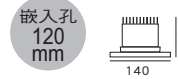

**CI-5016-4 870**

5W 嵌燈  
尺寸：φ 68mm H35mm  
輸入電壓：90~240V  
光源：台製 LED  
流明：400lm  
嵌入孔：55mm  
材質：鋁製品 電鍍

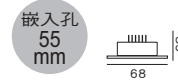

**CI-5016-5 870**

5W 嵌燈  
尺寸：φ 68mm H35mm  
輸入電壓：90~240V  
光源：台製 LED  
流明：400lm  
嵌入孔：55mm  
材質：鋁製品 電鍍

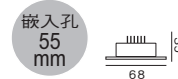

**CI-5016-6 870**

5W 嵌燈  
尺寸：φ 68mm H35mm  
輸入電壓：90~240V  
光源：台製 LED  
流明：400lm  
嵌入孔：55mm  
材質：鋁製品 電鍍

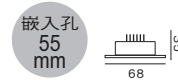





### CI-5017-1 3,300

COB 20W 嵌燈  
尺寸：φ 160mm H90mm  
輸入電壓：90~240V  
光源：CREE inside  
流明：1600lm  
嵌入孔：135mm  
材質：鋁製品 電鍍

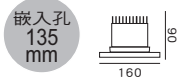

### CI-5017-2 3,300

COB 20W 嵌燈  
尺寸：φ 160mm H90mm  
輸入電壓：90~240V  
光源：CREE inside  
流明：1600lm  
嵌入孔：135mm  
材質：鋁製品 電鍍

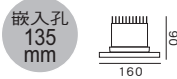

### CI-5017-3 3,300

COB 20W 嵌燈  
尺寸：φ 160mm H90mm  
輸入電壓：90~240V  
光源：CREE inside  
流明：1600lm  
嵌入孔：135mm  
材質：鋁製品 電鍍

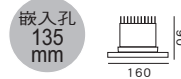

### CI-5017-4 1,900

COB 8W 嵌燈  
尺寸：φ 110mm H70mm  
輸入電壓：90~240V  
光源：CREE inside  
流明：800lm  
嵌入孔：95mm  
材質：鋁製品 電鍍

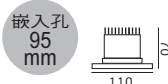

### CI-5017-5 1,900

COB 8W 嵌燈  
尺寸：φ 110mm H70mm  
輸入電壓：90~240V  
光源：CREE inside  
流明：700lm  
嵌入孔：95mm  
材質：鋁製品 電鍍

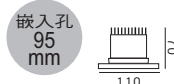

### CI-5017-6 1,900

COB 8W 嵌燈  
尺寸：φ 110mm H70mm  
輸入電壓：90~240V  
光源：CREE inside  
流明：700lm  
嵌入孔：95mm  
材質：鋁製品 電鍍

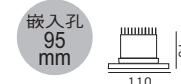

When considering ceiling lighting, Recessed Lighting has become a very popular option. Used frequently in home remodels and in new home construction recessed lighting works great in almost any location in the home.

# DOWN LIGHT

High efficiency high energy-saving



**CI-5018-1 3,830**

COB 30W 嵌燈  
 尺寸：φ 193mm H125mm  
 輸入電壓：90-240V  
 光源：CREE inside  
 流明：2800lm  
 嵌入孔：160mm  
 材質：鋁材 粉體烤漆



**CI-5018-2 3,580**

COB 30W 嵌燈  
 尺寸：φ 180mm H125mm  
 輸入電壓：90-240V  
 光源：CREE inside  
 流明：2800lm  
 嵌入孔：150mm  
 材質：鋁材 粉體烤漆

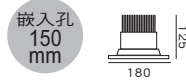

**CI-5018-3 2,450**

COB 20W 嵌燈  
 尺寸：φ 142mm H120mm  
 輸入電壓：90-240V  
 光源：CREE inside  
 流明：1800lm  
 嵌入孔：115mm  
 材質：鋁材 粉體烤漆

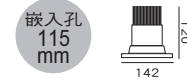

# LED -COB



When considering ceiling lighting, Recessed Lighting has become a very popular option. Used frequently in home remodels and in new home construction recessed lighting works great in almost any location in the home. Versatile and available in a multitude of sizes and lamp combinations recessed ceiling lighting is an affordable and attractive solution for whatever your application. Before buying be sure to read our blog to learn more about designing with recessed lighting and you will also want to read our article Recessed Lighting Tips and General Guidelines.

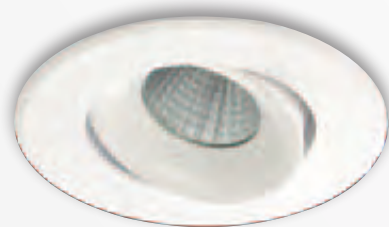

**CI-5018-4 1,580**

COB 10W 嵌燈  
 尺寸：φ 120mm H105mm  
 輸入電壓：90-240V  
 光源：CREE inside  
 流明：1000lm  
 嵌入孔：95mm  
 材質：鋁材 粉體烤漆

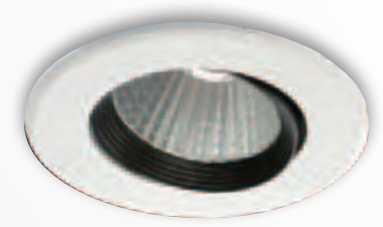
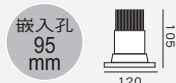

**CI-5018-5 1,420**

COB 10W 嵌燈  
 尺寸：φ 90mm H70mm  
 輸入電壓：90-240V  
 光源：CREE inside  
 流明：1000lm  
 嵌入孔：75mm  
 材質：鋁材 粉體烤漆





### CI-5019-1 3,480

COB 30W 嵌燈  
 尺寸：φ 160mm H115mm  
 輸入電壓：90~240V  
 光源：CREE inside  
 流明：2800lm  
 嵌入孔：145mm  
 材質：鋁材 粉體烤漆

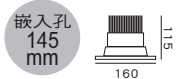

### CI-5019-2 2,500

COB 20W 嵌燈  
 尺寸：φ 140mm H115mm  
 輸入電壓：90~240V  
 光源：CREE inside  
 流明：1800lm  
 嵌入孔：120mm  
 材質：鋁材 粉體烤漆

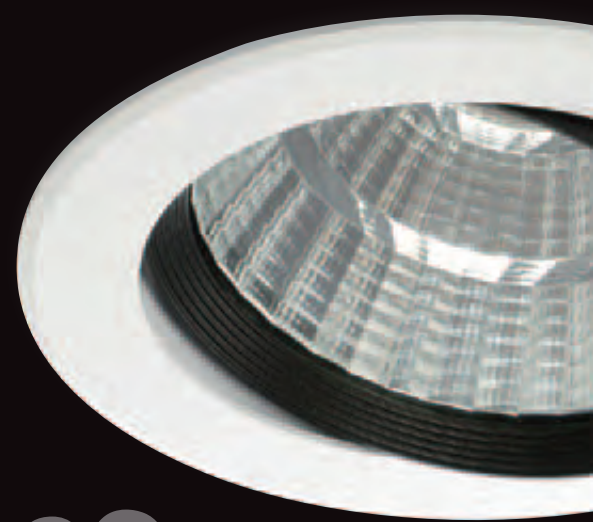
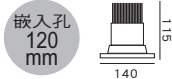

COB  
inside



### CI-5019-3 1,630

COB 10W 嵌燈  
 尺寸：φ 110mm H80mm  
 輸入電壓：90~240V  
 光源：CREE inside  
 流明：1000lm  
 嵌入孔：95mm  
 材質：鋁材 粉體烤漆

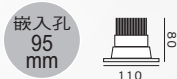

### CI-5019-4 2,200

COB 20W 嵌燈  
 尺寸：φ 110mm H100mm  
 輸入電壓：90~240V  
 光源：CREE inside  
 流明：2000lm  
 嵌入孔：95mm  
 材質：鋁材 粉體烤漆

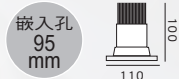

# DOWN LIGHT

High efficiency high energy-saving

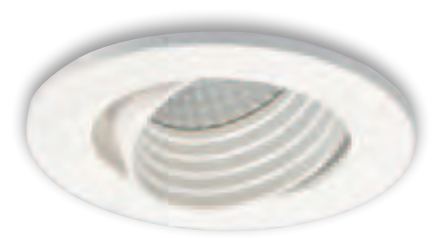
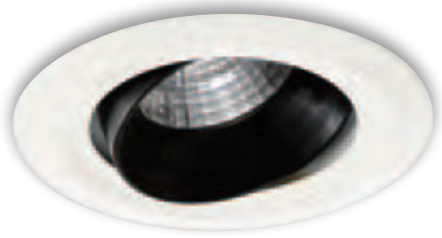

## CI-5020-1 1,480

COB 10W 嵌燈  
尺寸：φ 95mm H110mm  
輸入電壓：90~240V  
光源：CREE inside  
流明：900lm  
嵌入孔：85mm  
材質：鋁製品

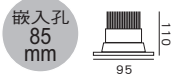

## CI-5020-2 1,500

COB 10W 嵌燈  
尺寸：φ 95mm H110mm  
輸入電壓：90~240V  
光源：CREE inside  
流明：900lm  
嵌入孔：85mm  
材質：鋁製品

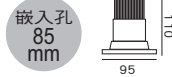

## CI-5020-3 1,480

COB 10W 嵌燈  
尺寸：φ 90mm H100mm  
輸入電壓：90~240V  
光源：CREE inside  
流明：900lm  
嵌入孔：80mm  
材質：鋁製品

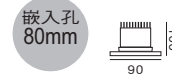

CI-5020-4



CI-5020-5



## CI-5020-4 1,340

COB 5W 吸頂燈  
尺寸：φ 75mm H120mm  
輸入電壓：90~240V  
光源：CREE inside  
流明：400lm  
材質：鋁製品

## CI-5020-5 1,530

COB 10W 嵌燈  
尺寸：φ 80mm H125mm  
輸入電壓：90~240V  
光源：CREE inside  
流明：900lm  
嵌入孔：70mm  
材質：鋁製品



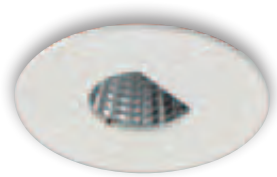

### CI-5021-1 990

COB 5W 嵌燈  
 尺寸：φ 40mm H45mm  
 輸入電壓：90~240V  
 光源：CREE inside  
 流明：300lm  
 嵌入孔：35mm  
 材質：鋁製品

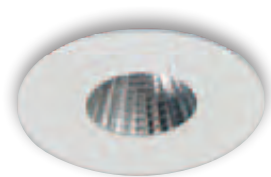
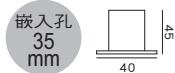

### CI-5021-2 990

COB 5W 嵌燈  
 尺寸：φ 40mm H45mm  
 輸入電壓：90~240V  
 光源：CREE inside  
 流明：300lm  
 嵌入孔：35mm  
 材質：鋁製品

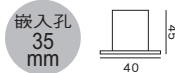

### CI-5021-3 990

COB 5W 嵌燈  
 尺寸：φ 40mm H45mm  
 輸入電壓：90~240V  
 光源：CREE inside  
 流明：300lm  
 嵌入孔：35mm  
 材質：鋁製品

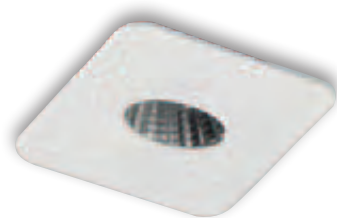
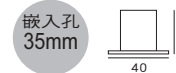

### CI-5021-4 990

COB 5W 嵌燈  
 尺寸：φ 40mm H45mm  
 輸入電壓：90~240V  
 光源：CREE inside  
 流明：300lm  
 嵌入孔：35mm  
 材質：鋁製品

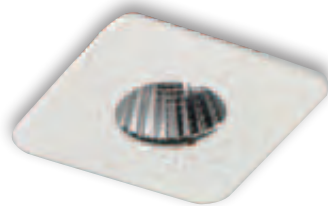
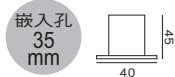
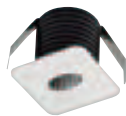

### CI-5021-5 990

COB 5W 嵌燈  
 尺寸：φ 40mm H45mm  
 輸入電壓：90~240V  
 光源：CREE inside  
 流明：300lm  
 嵌入孔：35mm  
 材質：鋁製品

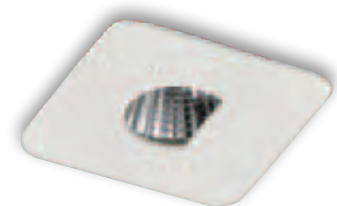
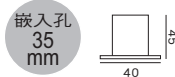
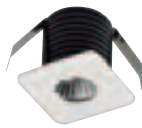

### CI-5021-6 990

COB 5W 嵌燈  
 尺寸：φ 40mm H45mm  
 輸入電壓：90~240V  
 光源：CREE inside  
 流明：300lm  
 嵌入孔：35mm  
 材質：鋁製品

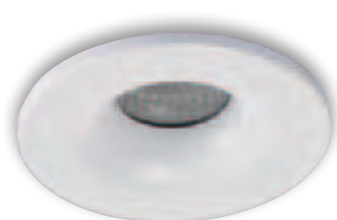
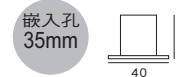

### CI-5021-7 990

COB 5W 嵌燈  
 尺寸：φ 50mm H40mm  
 輸入電壓：90~240V  
 光源：CREE inside  
 流明：300lm  
 嵌入孔：45mm  
 材質：鋁製品

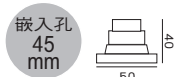

### CI-5021-8 990

COB 5W 嵌燈  
 尺寸：φ 50mm H40mm  
 輸入電壓：90~240V  
 光源：CREE inside  
 流明：300lm  
 嵌入孔：45mm  
 材質：鋁製品

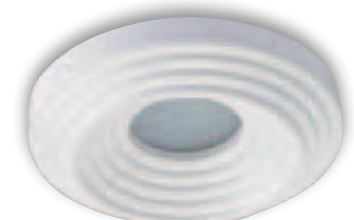
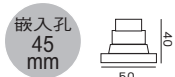

### CI-5021-9 990

COB 5W 嵌燈  
 尺寸：φ 50mm H40mm  
 輸入電壓：90~240V  
 光源：CREE inside  
 流明：300lm  
 嵌入孔：45mm  
 材質：鋁製品

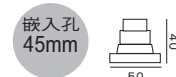

# DOWN LIGHT

High efficiency high energy-saving



## CI-5022-1 3,750

AR-111 15W 嵌燈  
尺寸：φ 190mm H170mm  
輸入電壓：90~240V  
光源：**OSRAM** inside  
流明：1300lm  
嵌入孔：175mm  
材質：鋁材 粉體烤漆



## CI-5022-2 1,990

AR-111 15W 嵌燈  
尺寸：φ 172mm H130mm  
輸入電壓：90~240V  
光源：**CREE** inside  
流明：1300lm  
嵌入孔：160mm  
材質：鋁材 粉體烤漆



## CI-5022-3 1,120

AR-111 10W 嵌燈  
尺寸：φ 172mm H130mm  
輸入電壓：90~240V  
光源：**NICHIA** inside  
流明：700lm  
嵌入孔：160mm  
材質：鋁材 粉體烤漆



## CI-5022-4 1,620

AR-111 15W 嵌燈  
尺寸：φ 172mm H130mm  
輸入電壓：90~240V  
光源：**OSRAM** inside  
流明：1300lm  
嵌入孔：160mm  
材質：鋁材 粉體烤漆





CI-5023-1

## CI-5023-1 2,440

PAR 15W 嵌燈  
 尺寸：φ 170mm H230mm  
 輸入電壓：90-240V  
 光源：OSRAM inside  
 流明：1300lm  
 嵌入孔：150mm  
 材質：鋁製品 粉體烤漆

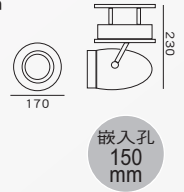

CI-5023-2

## CI-5023-2 4,570

30W 嵌燈  
 尺寸：φ 170mm H190mm  
 輸入電壓：90-240V  
 光源：NICHIA inside  
 流明：4000lm  
 嵌入孔：150mm  
 材質：鋁框 工程塑膠  
 粉體烤漆

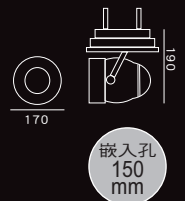

CI-5023-3

## CI-5023-3 5,500

COB 30W 嵌燈  
 尺寸：φ 170mm H160mm  
 輸入電壓：90-240V  
 光源：CREE inside  
 流明：3000lm  
 嵌入孔：150mm  
 材質：鋁製品 粉體烤漆



# DOWN LIGHT

High efficiency high energy-saving



**CI-5024-1 2,900**

AR-111 10W 嵌燈  
尺寸：φ 120mm H165mm  
輸入電壓：90-240V  
光源：**NICHIA** inside  
流明：700lm  
嵌入孔：150mm  
材質：鋁框 工程塑膠  
粉體烤漆



**CI-5024-2 3,400**

AR-111 15W 嵌燈  
尺寸：φ 120mm H165mm  
輸入電壓：90-240V  
光源：**OSRAM** inside  
流明：1300lm  
嵌入孔：150mm  
材質：鋁框 工程塑膠  
粉體烤漆



**CI-5024-3 3,780**

AR-111 15W 嵌燈  
尺寸：φ 120mm H165mm  
輸入電壓：90-240V  
光源：**CREE** inside  
流明：1300lm  
嵌入孔：150mm  
材質：鋁框 工程塑膠  
粉體烤漆

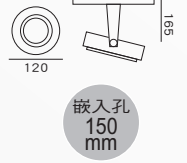

**LED** 15W  
**AR111**

**LED** 10W  
**AR111**

**LED** 15W  
**COB**



**CI-5024-4 2,900**

AR-111 10W 嵌燈  
尺寸：φ 120mm H165mm  
輸入電壓：90-240V  
光源：**NICHIA** inside  
流明：700lm  
嵌入孔：150mm  
材質：鋁框 工程塑膠  
粉體烤漆



**CI-5024-5 3,400**

AR-111 15W 嵌燈  
尺寸：φ 120mm H165mm  
輸入電壓：90-240V  
光源：**OSRAM** inside  
流明：1300lm  
嵌入孔：150mm  
材質：鋁框 工程塑膠  
粉體烤漆



**CI-5024-6 3,780**

AR-111 15W 嵌燈  
尺寸：φ 120mm H165mm  
輸入電壓：90-240V  
光源：**CREE** inside  
流明：1300lm  
嵌入孔：150mm  
材質：鋁框 工程塑膠  
粉體烤漆







CI-5025-1



CI-5025-2

## CI-5025-1 1,450

AR-111 15W 嵌燈  
 尺寸：φ 168mm H50mm  
 輸入電壓：90-240V  
 光源：**OSRAM** inside  
 流明：1300lm  
 嵌入孔：150mm  
 材質：鋁材 粉體烤漆

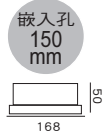

## CI-5025-2 1,130

15W 嵌燈  
 尺寸：φ 110mm H75mm  
 輸入電壓：90-240V  
 光源：**OSRAM** inside  
 流明：1300lm  
 嵌入孔：95mm  
 材質：鋁材 粉體烤漆

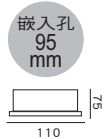

CI-5025-3

## CI-5025-3 1,175

AR-111 15W 嵌燈  
 尺寸：φ 140mm H45mm  
 輸入電壓：90-240V  
 光源：**OSRAM** inside  
 流明：1300lm  
 嵌入孔：000mm  
 材質：鋁材 電鍍白

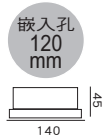

CI-5025-4

## CI-5025-4 400

10W 嵌燈  
 尺寸：φ 110mm H60mm  
 輸入電壓：90-240V  
 光源：**OSRAM** inside  
 流明：700lm  
 嵌入孔：95mm  
 材質：鋁材 電鍍白

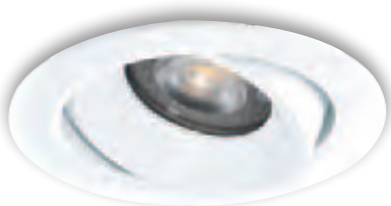
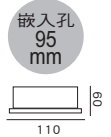

## CI-5025-5 1,000

COB 10W 嵌燈  
 尺寸：φ 110mm H50mm  
 輸入電壓：90-240V  
 光源：**CREE** inside  
 流明：900lm  
 嵌入孔：95mm  
 材質：鋁材 粉體烤漆

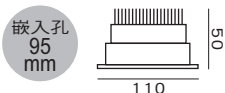

## CI-5025-6 625

10W 嵌燈  
 尺寸：φ 110mm H50mm  
 輸入電壓：90-240V  
 光源：**NICHIA** inside  
 流明：700lm  
 嵌入孔：95mm  
 材質：鋁材 粉體烤漆

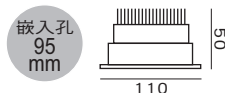

## CI-5025-7 1,000

COB 10W 嵌燈  
 尺寸：φ 110mm H50mm  
 輸入電壓：90-240V  
 光源：**CREE** inside  
 流明：900lm  
 嵌入孔：95mm  
 材質：鋁材 粉體烤漆

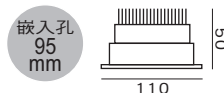

## CI-5025-8 625

10W 嵌燈  
 尺寸：φ 110mm H50mm  
 輸入電壓：90-240V  
 光源：**NICHIA** inside  
 流明：700lm  
 嵌入孔：95mm  
 材質：鋁材 粉體烤漆

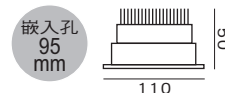

# DOWN LIGHT

High efficiency high energy-saving



CI-5026-1



CI-5026-2



CI-5026-3

CI-5026-4

## CI-5026-1 400

12W 嵌燈  
尺寸：φ 180mm H50mm  
輸入電壓：90-240V  
光源：台製 LED  
流明：1000lm  
嵌入孔：150mm  
材質：鋁材 粉體烤漆

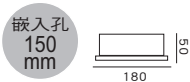

## CI-5026-2 400

12W 嵌燈  
尺寸：φ 150mm H45mm  
輸入電壓：90-240V  
光源：台製 LED  
流明：1000lm  
嵌入孔：120mm  
材質：鋁製品 PC 罩



## CI-5026-3 375

10W 嵌燈  
尺寸：φ 110mm H45mm  
輸入電壓：90-240V  
光源：台製 LED  
流明：900lm  
嵌入孔：93mm  
材質：鋁製品 PC 罩

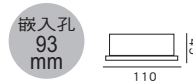

## CI-5026-4 375

10W 嵌燈  
尺寸：φ 100mm H45mm  
輸入電壓：90-240V  
光源：台製 LED  
流明：900lm  
嵌入孔：75mm  
材質：鋁製品 PC 罩

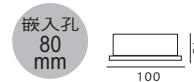



### CI-5027-1 625

12W 嵌燈  
尺寸：φ 180mm H50mm  
光源：OSRAM inside  
流明：1000lm  
嵌入孔：150mm  
材質：鋁製品 粉體烤漆

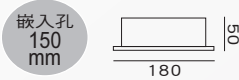

### CI-5027-2 1,250

18W 嵌燈  
尺寸：φ 180mm H50mm  
輸入電壓：90~240V  
光源：OSRAM inside  
流明：1500lm  
嵌入孔：150mm  
材質：鋁製品 粉體烤漆

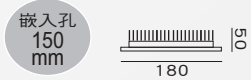

### CI-5027-3 625

12W 嵌燈  
尺寸：φ 148mm H45mm  
光源：OSRAM inside  
流明：1000lm  
嵌入孔：120mm  
材質：鋁製品 粉體烤漆



### CI-5027-4 1,250

18W 嵌燈  
尺寸：φ 180mm H50mm  
輸入電壓：90~240V  
光源：OSRAM inside  
流明：1500lm  
嵌入孔：150mm  
材質：鋁製品 粉體烤漆

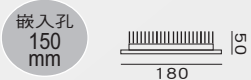

# DOWN LIGHT

High efficiency high energy-saving

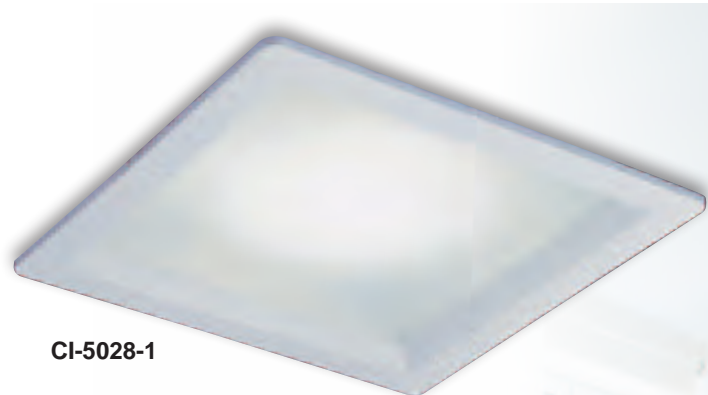

CI-5028-1

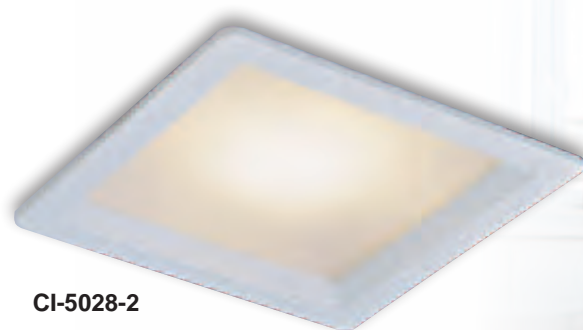

CI-5028-2

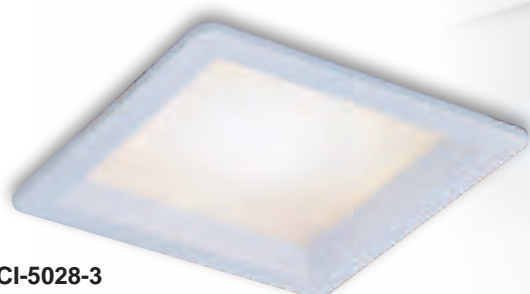

CI-5028-3



## CI-5028-1 1,920

18W 嵌燈  
尺寸：□ 220mm H70mm  
輸入電壓：90~240V  
光源：OSRAM inside  
流明：1500lm  
嵌入孔：190×190mm  
材質：鋁材 粉體烤漆

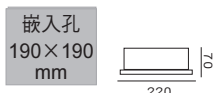

## CI-5028-2 1,480

12W 嵌燈  
尺寸：□ 180mm H70mm  
輸入電壓：90~240V  
光源：OSRAM inside  
流明：1000lm  
嵌入孔：155×155mm  
材質：鋁材 粉體烤漆

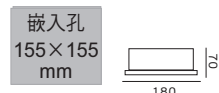

## CI-5028-3 1,180

12W 嵌燈  
尺寸：□ 140mm H60mm  
輸入電壓：90~240V  
光源：OSRAM inside  
流明：1000lm  
嵌入孔：120×120mm  
材質：鋁材 粉體烤漆

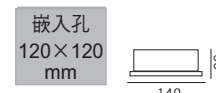



CI-5029-1



CI-5029-2

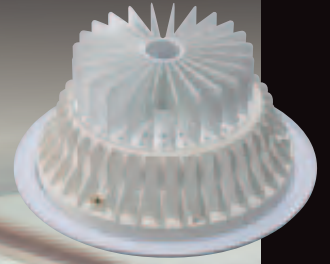
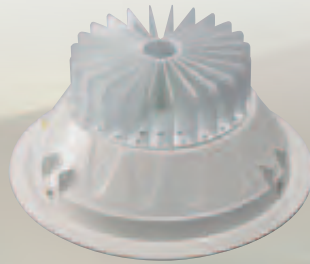

CI-5029-3

### CI-5029-1 4,240

30W 嵌燈  
尺寸：φ 245mm H115mm  
輸入電壓：90~240V  
光源：CREE inside  
流明：2800lm  
嵌入孔：200mm  
材質：鋁壓鑄 PC 罩

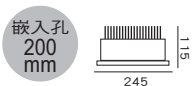

### CI-5029-2 4,240

30W 嵌燈  
尺寸：φ 245mm H115mm  
輸入電壓：90~240V  
光源：CREE inside  
流明：2800lm  
嵌入孔：200mm  
材質：鋁壓鑄 PC 罩

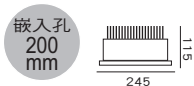

### CI-5029-3 1,810

18W 嵌燈  
尺寸：φ 220mm H55mm  
輸入電壓：90~240V  
光源：OSRAM inside  
流明：1500lm  
嵌入孔：200mm  
材質：鋁材 粉體烤漆

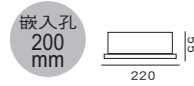

# DOWN LIGHT

High efficiency high energy-saving

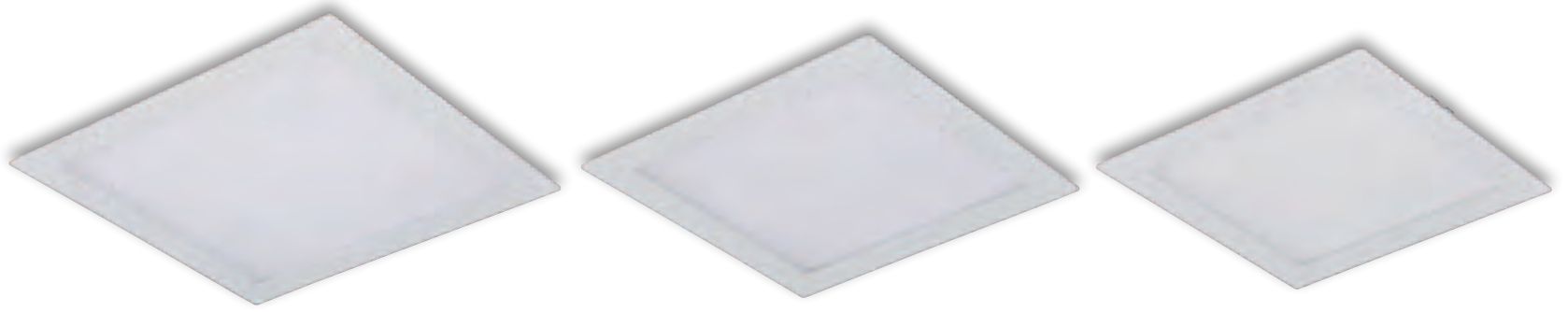

## CI-5030-1 1,280

COB 24W 嵌燈  
尺寸：□ 300mm H25mm  
輸入電壓：90~240V  
光源：CREE inside  
流明：2400lm  
嵌入孔：275×275mm  
材質：鋁製品 PC 罩

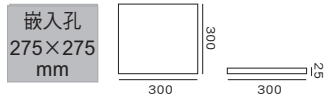

## CI-5030-2 950

COB 18W 嵌燈  
尺寸：□ 225mm H25mm  
輸入電壓：90~240V  
光源：CREE inside  
流明：1800lm  
嵌入孔：200×200mm  
材質：鋁製品 PC 罩

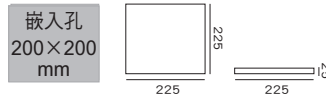

## CI-5030-3 880

COB 15W 嵌燈  
尺寸：□ 200mm H25mm  
輸入電壓：90~240V  
光源：CREE inside  
流明：1500lm  
嵌入孔：180×180mm  
材質：鋁製品 PC 罩

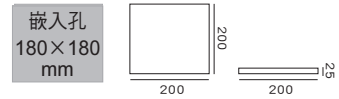

## CI-5030-4 2,500

COB 40W 嵌燈  
尺寸：□ 600mm H10mm  
輸入電壓：90~240V  
光源：CREE inside  
流明：4000lm  
嵌入孔：600×600mm  
材質：鋁製品 PC 罩

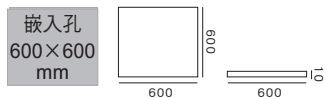

CI-5030-4



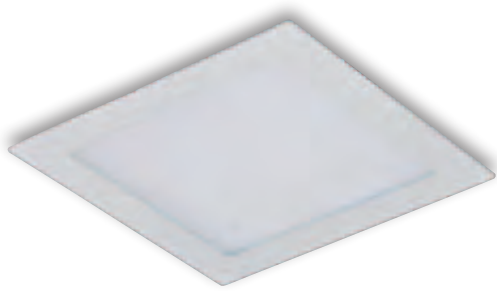

### CI-5031-1 800

COB 12W 嵌燈  
尺寸：□ 171mm H25mm  
輸入電壓：90~240V  
光源：CREE inside  
流明：1200lm  
嵌入孔：147×147mm  
材質：鋁製品 PC 罩

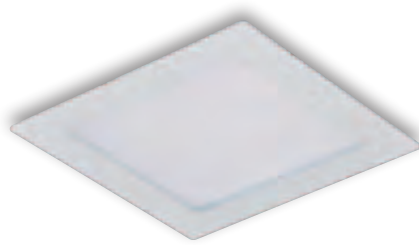
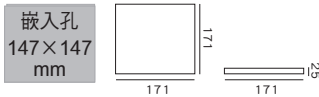

### CI-5031-2 600

COB 9W 嵌燈  
尺寸：□ 147mm H25mm  
輸入電壓：90~240V  
光源：CREE inside  
流明：900lm  
嵌入孔：85mm  
材質：鋁製品 PC 罩

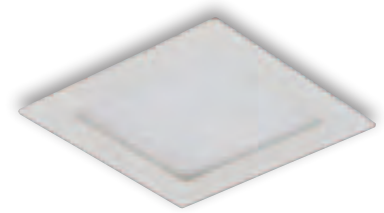
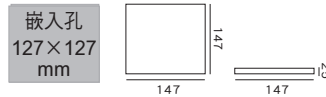

### CI-5031-3 480

COB 6W 嵌燈  
尺寸：□ 120mm H25mm  
輸入電壓：90~240V  
光源：CREE inside  
流明：600lm  
嵌入孔：99×99mm  
材質：鋁製品 PC 罩

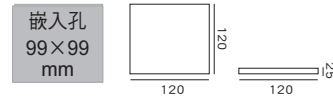

CI-5031-4



CI-5031-5

### CI-5031-4 1,250

COB 24W 嵌燈  
尺寸：φ 300mm H25mm  
輸入電壓：90~240V  
光源：CREE inside  
流明：2400lm  
嵌入孔：275mm  
材質：鋁製品 PC 罩



### CI-5031-5 930

COB 18W 嵌燈  
尺寸：φ 223mm H25mm  
輸入電壓：90~240V  
光源：CREE inside  
流明：1800lm  
嵌入孔：200mm  
材質：鋁製品 PC 罩



### CI-5031-6 850

COB 15W 嵌燈  
尺寸：φ 200mm H25mm  
輸入電壓：90~240V  
光源：CREE inside  
流明：1500lm  
嵌入孔：180mm  
材質：鋁製品 PC 罩

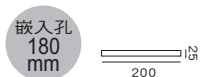

### CI-5031-7 800

COB 12W 嵌燈  
尺寸：φ 170mm H25mm  
輸入電壓：90~240V  
光源：CREE inside  
流明：1200lm  
嵌入孔：151mm  
材質：鋁製品 PC 罩



### CI-5031-8 580

COB 9W 嵌燈  
尺寸：φ 145mm H25mm  
輸入電壓：90~240V  
光源：CREE inside  
流明：900lm  
嵌入孔：128mm  
材質：鋁製品 PC 罩



# SPOT LIGHT

High efficiency high energy-saving

## SL-209-N



- 燈泡規格 :MR-16 投射燈
- 消耗功率 :6W
- LED: **NICHIA** Inside
- 輸入電壓 :AC/DC 12V
- 輸出流明 :400lm  
(取代 75W 鎢絲燈泡)
- 顏色 :W/WW
- 演色性 CRI:84
- 出光角度 :25° 45°
- 工作壽命 :30,000 小時
- 需使用於開放性空間
- 材質 : 鋁鍍片
- 尺寸 (mm): φ 49\*41



CI-5032-1



CI-5032-2

## CI-5032-1 1,430

MR-16 6W 軌道燈  
尺寸：φ 80mm H400mm  
輸入電壓：90-240V  
光源：**NICHIA** inside  
流明：400lm  
材質：鋁製品 粉體烤漆

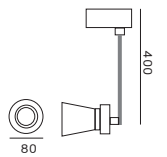

## CI-5032-2 1,430

MR-16 6W 軌道燈  
尺寸：φ 80mm H400mm  
輸入電壓：90-240V  
光源：**NICHIA** inside  
流明：400lm  
材質：鋁製品 粉體烤漆

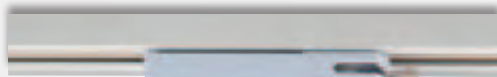
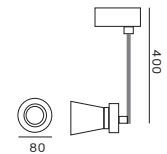

## CI-5032-3 1,040

MR-16 6W 軌道燈  
尺寸：φ 50mm H190mm  
輸入電壓：90-240V  
光源：**NICHIA** inside  
流明：400lm  
材質：鋁製品 粉體烤漆

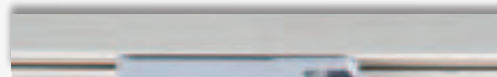
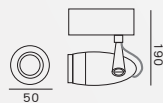

## CI-5032-4 1,170

MR-16 6W 軌道燈  
尺寸：φ 56mm H120mm  
輸入電壓：90-240V  
光源：**NICHIA** inside  
流明：400lm  
材質：鋁製品 粉體烤漆

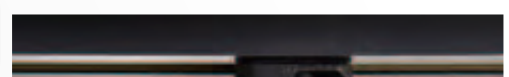
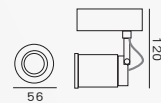

## CI-5032-5 1,050

AC MR-16 6W 軌道燈  
尺寸：φ 120mm H220mm  
輸入電壓：90-240V  
光源：**OSRAM** inside  
流明：400lm  
材質：鐵材 粉體烤漆

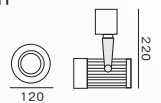





CI-5033-1

**CI-5033-1 1,350**

AC MR-16 6W 軌道燈  
 尺寸：φ 80mm H400mm  
 輸入電壓：90-240V  
 光源：**OSRAM** inside  
 流明：400lm  
 材質：鋁製品 粉體烤漆

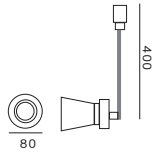

CI-5033-2

**CI-5033-2 1,350**

AC MR-16 6W 軌道燈  
 尺寸：φ 80mm H400mm  
 輸入電壓：90-240V  
 光源：**OSRAM** inside  
 流明：400lm  
 材質：鋁製品 粉體烤漆

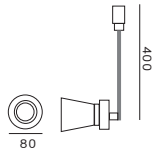

**CI-5033-3 960**

AC MR-16 6W 軌道燈  
 尺寸：φ 50mm H190mm  
 輸入電壓：90-240V  
 光源：**OSRAM** inside  
 流明：400lm  
 材質：鋁製品 粉體烤漆

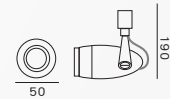

**CI-5033-4 1,090**

AC MR-16 6W 軌道燈  
 尺寸：φ 56mm H120mm  
 輸入電壓：90-240V  
 光源：**OSRAM** inside  
 流明：400lm  
 材質：鋁製品 粉體烤漆

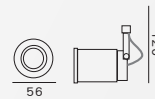

**SL-209-AC**

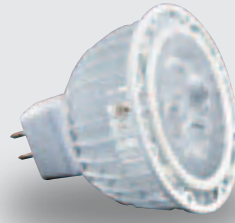

- 燈泡規格:MR-16 投射燈
- 消耗功率:6W
- LED:**OSRAM** Inside
- 輸入電壓:AC/DC 12V
- 輸出流明:400lm  
(取代 75W 鎢絲燈泡)
- 顏色:W/WW
- 演色性 CRI:84
- 出光角度:25° 45°
- 工作壽命:30,000 小時
- 需使用於開放性空間
- 材質:鋁鍍片
- 尺寸(mm):φ 49\*41



# SPOT LIGHT

High efficiency high energy-saving



**CI-5034-1 1,010**

MR-16 6W 軌道燈  
尺寸：φ 60mm H170mm  
輸入電壓：90-240V  
光源：NICHIA inside  
流明：400lm  
材質：鋁製品 粉體烤漆

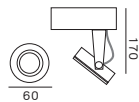

**CI-5034-2 1,140**

MR-16 6W 軌道燈  
尺寸：φ 70mm H170mm  
輸入電壓：90-240V  
光源：NICHIA inside  
流明：400lm  
材質：鋁製品 粉體烤漆

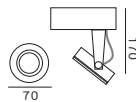

**CI-5034-3 1,010**

MR-16 6W 軌道燈  
尺寸：φ 60mm H200mm  
輸入電壓：90-240V  
光源：NICHIA inside  
流明：400lm  
材質：鋁製品 粉體烤漆

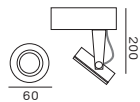

**CI-5034-4 1,140**

MR-16 6W 軌道燈  
尺寸：φ 60mm H170mm  
輸入電壓：90-240V  
光源：NICHIA inside  
流明：400lm  
材質：鋁製品 粉體烤漆

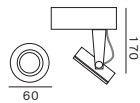

CI-5034-4



CI-5034-5

**CI-5034-5 1,100**

MR-16 6W 軌道燈  
尺寸：φ 60mm H170mm  
輸入電壓：90-240V  
光源：NICHIA inside  
流明：400lm  
材質：鋁製品 粉體烤漆

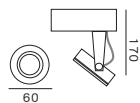

**CI-5034-6 1,490**

MR-16 6W 軌道燈  
尺寸：φ 60mm H190mm  
輸入電壓：90-240V  
光源：NICHIA inside  
流明：400lm  
材質：鋁製品 粉體烤漆

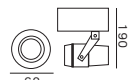

CI-5034-6



CI-5034-7

**CI-5034-7 1,590**

MR-16 6W 軌道燈  
尺寸：φ 60mm H190mm  
輸入電壓：90-240V  
光源：NICHIA inside  
流明：400lm  
材質：鋁製品 粉體烤漆

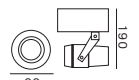



### CI-5035-1 930

AC MR-16 6W 軌道燈  
 尺寸：φ 60mm H170mm  
 輸入電壓：90-240V  
 光源：OSRAM inside  
 流明：400lm  
 材質：鋁製品 粉體烤漆

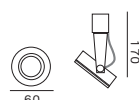

### CI-5035-2 1,060

AC MR-16 6W 軌道燈  
 尺寸：φ 70mm H170mm  
 輸入電壓：90-240V  
 光源：OSRAM inside  
 流明：400lm  
 材質：鋁製品 粉體烤漆

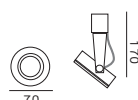

### CI-5035-3 930

AC MR-16 6W 軌道燈  
 尺寸：φ 60mm H200mm  
 輸入電壓：90-240V  
 光源：OSRAM inside  
 流明：400lm  
 材質：鋁製品 粉體烤漆

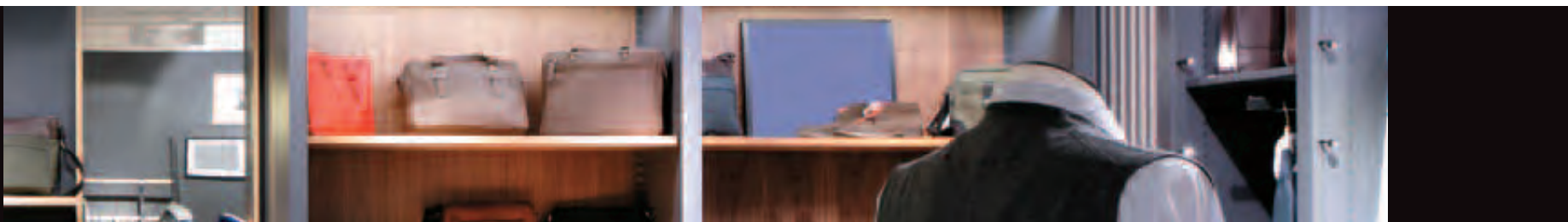
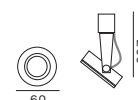

CI-5035-4



CI-5035-5

### CI-5035-4 1,060

AC MR-16 6W 軌道燈  
 尺寸：φ 60mm H170mm  
 輸入電壓：90-240V  
 光源：OSRAM inside  
 流明：400lm  
 材質：鋁製品 粉體烤漆

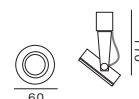

### CI-5035-5 1,030

AC MR-16 6W 軌道燈  
 尺寸：φ 60mm H170mm  
 輸入電壓：90-240V  
 光源：OSRAM inside  
 流明：400lm  
 材質：鋁製品 粉體烤漆

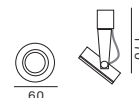

CI-5035-6



CI-5035-7

### CI-5035-6 1,420

AC MR-16 6W 軌道燈  
 尺寸：φ 60mm H190mm  
 輸入電壓：90-240V  
 光源：OSRAM inside  
 流明：400lm  
 材質：鋁製品 粉體烤漆

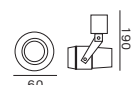

### CI-5035-7 1,520

AC MR-16 6W 軌道燈  
 尺寸：φ 60mm H190mm  
 輸入電壓：90-240V  
 光源：OSRAM inside  
 流明：400lm  
 材質：鋁製品 粉體烤漆

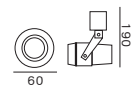

# SPOT LIGHT

High efficiency high energy-saving

## CI-5036-1 1,400

MR-16 6W 軌道燈  
 尺寸：φ72mm H160mm  
 輸入電壓：90-240V  
 光源：NICHIA inside  
 流明：400lm  
 材質：鋁製品 粉體烤漆

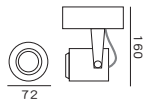

CI-5036-1



CI-5036-2

## CI-5036-2 1,490

MR-16 6W 軌道燈  
 尺寸：φ72mm H160mm  
 輸入電壓：90-240V  
 光源：NICHIA inside  
 流明：400lm  
 材質：鋁製品 粉體烤漆

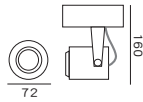

CI-5036-3



CI-5036-4

## CI-5036-3 1,660

MR-16 6W 軌道燈  
 尺寸：φ60mm H200mm  
 輸入電壓：90-240V  
 光源：NICHIA inside  
 流明：400lm  
 材質：鋁製品 粉體烤漆

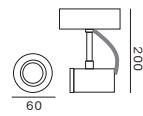

## CI-5036-4 1,660

MR-16 6W 軌道燈  
 尺寸：φ60mm H200mm  
 輸入電壓：90-240V  
 光源：NICHIA inside  
 流明：400lm  
 材質：鋁製品 粉體烤漆

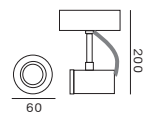

# LED-MR16

# SPOT



## CI-5036-5 1,040

MR-16 6W 軌道燈  
 尺寸：φ65mm H160mm  
 輸入電壓：90-240V  
 光源：NICHIA inside  
 流明：400lm  
 材質：鋁製品 粉體烤漆

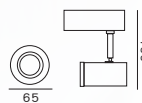

## CI-5036-6 1,100

MR-16 6W 軌道燈  
 尺寸：φ80mm H150mm  
 輸入電壓：90-240V  
 光源：NICHIA inside  
 流明：400lm  
 材質：鋁製品 粉體烤漆

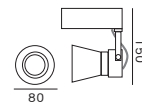

## CI-5036-7 1,100

MR-16 6W 軌道燈  
 尺寸：φ80mm H150mm  
 輸入電壓：90-240V  
 光源：NICHIA inside  
 流明：400lm  
 材質：鋁製品 粉體烤漆

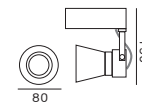



CI-5037-1



CI-5037-2

**CI-5037-1 1,320**

AC MR-16 6W 軌道燈  
 尺寸：φ 72mm H160mm  
 輸入電壓：90-240V  
 光源：OSRAM inside  
 流明：400lm  
 材質：鋁製品 粉體烤漆

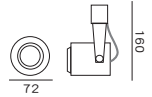

CI-5037-3



CI-5037-4

**CI-5037-2 1,420**

AC MR-16 6W 軌道燈  
 尺寸：φ 72mm H160mm  
 輸入電壓：90-240V  
 光源：OSRAM inside  
 流明：400lm  
 材質：鋁製品 粉體烤漆

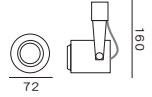

**CI-5037-3 1,580**

AC MR-16 6W 軌道燈  
 尺寸：φ 60mm H200mm  
 輸入電壓：90-240V  
 光源：OSRAM inside  
 流明：400lm  
 材質：鋁製品 粉體烤漆

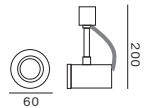

**CI-5037-4 1,580**

AC MR-16 6W 軌道燈  
 尺寸：φ 60mm H200mm  
 輸入電壓：90-240V  
 光源：OSRAM inside  
 流明：400lm  
 材質：鋁製品 粉體烤漆

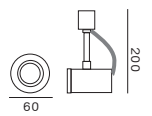

**CI-5037-5 960**

AC MR-16 6W 軌道燈  
 尺寸：φ 65mm H160mm  
 輸入電壓：90-240V  
 光源：OSRAM inside  
 流明：400lm  
 材質：鋁製品 粉體烤漆

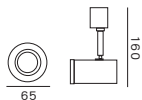

**CI-5037-6 1,030**

AC MR-16 6W 軌道燈  
 尺寸：φ 80mm H150mm  
 輸入電壓：90-240V  
 光源：OSRAM inside  
 流明：400lm  
 材質：鋁製品 粉體烤漆

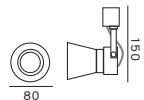

**CI-5037-7 1,030**

AC MR-16 6W 軌道燈  
 尺寸：φ 80mm H150mm  
 輸入電壓：90-240V  
 光源：OSRAM inside  
 流明：400lm  
 材質：鋁製品 粉體烤漆

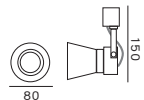

# SPOT LIGHT

High efficiency high energy-saving



CI-5038-1

## CI-5038-1 1,130

尺寸：φ 290mm H145mm  
光源：E27 LED 10W  
流明：1300lm  
材質：鋁材 粉體烤漆

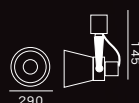

## CI-5038-2 800

尺寸：φ 90mm H220mm  
光源：E27 LED 10W  
流明：900lm  
材質：鐵材 粉體烤漆

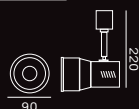

CI-5038-2



CI-5038-3

## CI-5038-3 800

尺寸：φ 90mm H220mm  
光源：E27 LED 10W  
流明：900lm  
材質：鐵材 粉體烤漆

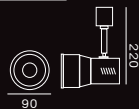

CI-5038-4



CI-5038-5

## CI-5038-4 930

尺寸：φ 90mm H160mm  
光源：E27 LED 10W  
流明：900lm  
材質：鐵材 粉體烤漆

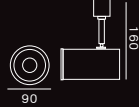

## CI-5038-5 930

尺寸：φ 90mm H160mm  
光源：E27 LED 10W  
流明：900lm  
材質：鐵材 粉體烤漆

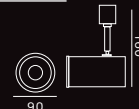

## CI-5038-6 1,940

尺寸：φ 95mm H200mm  
光源：E27 PAR30 LED 15W  
流明：1300lm  
材質：鋁製品 粉體烤漆



CI-5038-6



CI-5038-7

## CI-5038-7 1,940

尺寸：φ 95mm H200mm  
光源：E27 PAR30 LED 15W  
流明：1300lm  
材質：鋁製品 粉體烤漆





**CI-5039-1 2,640**

尺寸：φ 120mm H220mm  
光源：LED-COB 15W  
流明：1300lm  
材質：鐵材 粉體烤漆

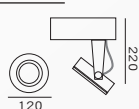

**CI-5039-2 2,270**

尺寸：φ 120mm H220mm  
光源：AR111-LED 15W  
流明：1300lm  
材質：鐵材 粉體烤漆

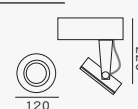

**CI-5039-3 1,770**

尺寸：φ 120mm H220mm  
光源：AR111-LED 10W  
流明：700lm  
材質：鐵材 粉體烤漆

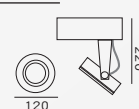

**CI-5039-4 2,640**

尺寸：φ 120mm H220mm  
光源：AR111-LED 15W  
流明：1300lm  
材質：鐵材 粉體烤漆

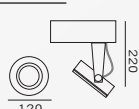

**CI-5039-5 2,270**

尺寸：φ 120mm H220mm  
光源：AR111-LED 15W  
流明：1300lm  
材質：鐵材 粉體烤漆

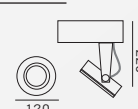

**CI-5039-6 1,770**

尺寸：φ 120mm H220mm  
光源：AR111-LED 10W  
流明：700lm  
材質：鐵材 粉體烤漆

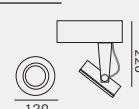

# SPOT LIGHT

High efficiency high energy-saving



CI-5040-1



CI-5040-2



CI-5040-3



CI-5040-4

## CI-5040-1 1,880

尺寸：φ 120mm H220mm  
光源：PAR 30 LED 15W  
流明：1300lm  
材質：鐵材 粉體烤漆

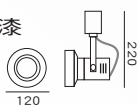

## CI-5040-2 1,880

尺寸：φ 120mm H220mm  
光源：PAR 30 LED 15W  
流明：1300lm  
材質：鐵材 粉體烤漆

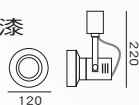

## CI-5040-3 1,880

尺寸：φ 120mm H220mm  
光源：PAR 30 LED 15W  
流明：1300lm  
材質：鐵材 粉體烤漆

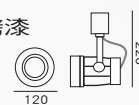

## CI-5040-4 2,200

尺寸：φ 120mm H220mm  
光源：PAR 30 LED 15W  
流明：1300lm  
材質：鐵材 粉體烤漆

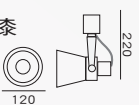



### CI-5041-1 1,990

尺寸：φ 120mm H220mm  
光源：AR-111 LED 15W  
流明：1300lm  
材質：鐵材 粉體烤漆

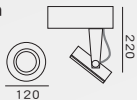

### CI-5041-2 2,370

尺寸：φ 120mm H220mm  
光源：AR-111 LED 15W  
流明：1300lm  
材質：鐵材 粉體烤漆



### CI-5041-3 1,880

尺寸：φ 120mm H220mm  
光源：PAR-30 LED 15W  
流明：1300lm  
材質：鐵材 粉體烤漆

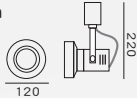

CI-5041-1



CI-5041-2



CI-5041-3



# SPOT LIGHT

High efficiency high energy-saving

## CI-5042-1 1,880

尺寸：φ 270mm H150mm  
 光源：E27 PAR-30 LED 15W  
 流明：1300lm  
 材質：鋁材 粉體烤漆

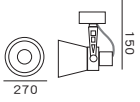

## CI-5042-2 1,880

尺寸：φ 290mm H145mm  
 光源：E27 PAR-30 LED 15W  
 流明：900lm  
 材質：鋁材 粉體烤漆

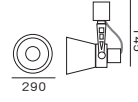

## CI-5042-3 1,550

尺寸：φ 140mm H250mm  
 光源：E27 PAR30 LED 15W  
 流明：1300lm  
 材質：鐵材 粉體烤漆

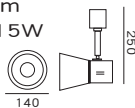

CI-5042-3



CI-5042-4

## CI-5042-4 1,550

尺寸：φ 140mm H250mm  
 光源：E27 PAR30 LED 15W  
 流明：1300lm  
 材質：鐵材 粉體烤漆

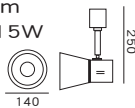

## CI-5042-5 1,680

尺寸：φ 110mm H250mm  
 光源：E27 PAR30 LED 15W  
 流明：1300lm  
 材質：鐵材 粉體烤漆

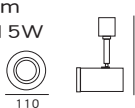

CI-5042-5



CI-5042-6

## CI-5042-6 1,780

尺寸：φ 110mm H250mm  
 光源：E27 PAR30 LED 15W  
 流明：1300lm  
 材質：鐵材 粉體烤漆

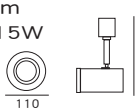

### CI-5043-1 1,130

尺寸：φ 270mm H150mm  
光源：E27 LED 10W  
流明：900lm  
材質：鋁材 粉體烤漆

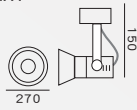

CI-5043-1



CI-5043-2

### CI-5043-2 1,130

尺寸：φ 270mm H150mm  
光源：E27 LED 10W  
流明：900lm  
材質：鋁材 粉體烤漆

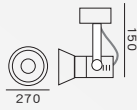

CI-5043-3

### CI-5043-3 1,130

尺寸：φ 270mm H155mm  
光源：E27 LED 10W  
流明：900lm  
材質：鋁材 粉體烤漆

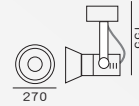

# LED-E27



### CI-5043-4 1,880

尺寸：φ 270mm H150mm  
光源：E27 PAR30 LED 15W  
流明：1300lm  
材質：鋁材 粉體烤漆

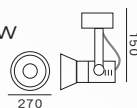

### CI-5043-5 1,880

尺寸：φ 270mm H150mm  
光源：E27 PAR30 LED 15W  
流明：1300lm  
材質：鋁材 粉體烤漆

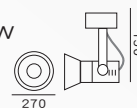

### CI-5043-6 1,880

尺寸：φ 270mm H155mm  
光源：E27 PAR30 LED 15W  
流明：1300lm  
材質：鋁材 粉體烤漆



# SPOT LIGHT

High efficiency high energy-saving



CI-5044-1



CI-5044-2



CI-5044-3



CI-5044-4

## CI-5044-1 6,950

COB 30W×2 軌道燈  
 尺寸：φ 280mm H200mm  
 輸入電壓：90~240V  
 光源：CREE inside  
 流明：6000lm  
 材質：鋁製品 電鍍金

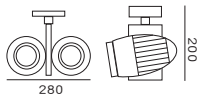

## CI-5044-2 3,700

COB 30W 軌道燈  
 尺寸：φ 160mm H200mm  
 輸入電壓：90~240V  
 光源：CREE inside  
 流明：3000lm  
 材質：鋁製品 電鍍金

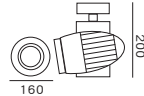

## CI-5044-3 6,950

30W×2 軌道燈  
 尺寸：φ 280mm H200mm  
 輸入電壓：90~240V  
 光源：NICHIA inside  
 流明：8000lm  
 材質：鋁製品 粉體烤漆

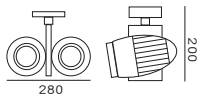

## CI-5044-4 3,700

30W 軌道燈  
 尺寸：φ 160mm H200mm  
 輸入電壓：90~240V  
 光源：NICHIA inside  
 流明：4000lm  
 材質：鋁製品 粉體烤漆

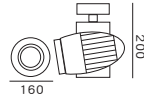

## CI-5045-1 7,700

30W×2 軌道燈  
尺寸：φ 280mm H200mm  
輸入電壓：90~240V  
光源：NICHIA insid  
流明：8000lm  
材質：鋁製品 粉體烤漆

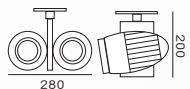

CI-5045-1

## CI-5045-2 4,450

30W 軌道燈  
尺寸：φ 160mm H200mm  
輸入電壓：90~240V  
光源：NICHIA insid  
流明：4000lm  
材質：鋁製品 粉體烤漆

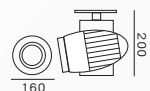

CI-5045-2

## CI-5045-3 7,700

COB 30W×2 軌道燈  
尺寸：φ 280mm H200mm  
輸入電壓：90~240V  
光源：CREE inside  
流明：6000lm  
材質：鋁製品 電鍍

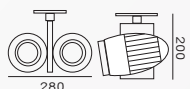

CI-5045-3

## CI-5045-4 4,450

COB 30W 軌道燈  
尺寸：φ 160mm H200mm  
輸入電壓：90~240V  
光源：CREE inside  
流明：3000lm  
材質：鋁製品 電鍍

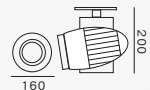

CI-5045-4



嵌入式軌道底板



# SPOT LIGHT

High efficiency high energy-saving



CI-5046-1

CI-5046-2

CI-5046-3

## CI-5046-1 10,790

30W×3 軌道燈  
 尺寸：φ 600mm H200mm  
 輸入電壓：90-240V  
 光源：NICHIA inside  
 流明：12000lm  
 材質：鋁製品 電鍍金



## CI-5046-2 7,390

30W×2 軌道燈  
 尺寸：φ 600mm H200mm  
 輸入電壓：90-240V  
 光源：NICHIA inside  
 流明：8000lm  
 材質：鋁製品 電鍍金



## CI-5046-3 3,970

30W 軌道燈  
 尺寸：φ 100mm H200mm  
 輸入電壓：90-240V  
 光源：CREE inside  
 流明：3000lm  
 材質：鋁製品 電鍍金



## CI-5047-1 10,790

COB 30W×3 軌道燈  
尺寸：φ 500mm H200mm  
輸入電壓：90-240V  
光源：CREE inside  
流明：9000lm  
材質：鋁製品 粉體烤漆

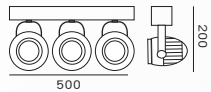

## CI-5047-2 7,390

COB 30W×2 軌道燈  
尺寸：φ 500mm H200mm  
輸入電壓：90-240V  
光源：CREE inside  
流明：6000lm  
材質：鋁製品 粉體烤漆

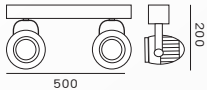

CI-5047-1

CI-5047-2

## CI-5047-3 3,970

30W 軌道燈  
尺寸：φ 100mm H200mm  
輸入電壓：90-240V  
光源：NICHIA inside  
流明：4000lm  
材質：鋁製品 粉體烤漆



## CI-5047-4 3,610

30W 軌道燈  
尺寸：φ 100mm H200mm  
輸入電壓：90-240V  
光源：CREE inside  
流明：3000lm  
材質：鋁製品 粉體烤漆



## CI-5047-5 3,610

30W 軌道燈  
尺寸：φ 100mm H200mm  
輸入電壓：90-240V  
光源：CREE inside  
流明：3000lm  
材質：鋁製品 電鍍銀



# SPOT LIGHT

High efficiency high energy-saving



**CI-5048-1 790**

AC MR-16 6W 軌道燈  
 尺寸 (mm) : L80×H150×W60  
 輸入電壓 : AC90-240V  
 光源 : **OSRAM** inside  
 輸出流明 : 400lm  
 工作壽命 : 30000 小時

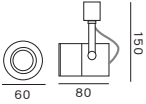

**CI-5048-2 790**

AC MR-16 6W 軌道燈  
 尺寸 (mm) : L80×H150×W60  
 輸入電壓 : AC90-240V  
 光源 : **OSRAM** inside  
 輸出流明 : 400lm  
 工作壽命 : 30000 小時

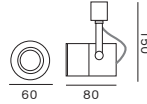

**CI-5048-3 1,430**

AC MR-16 6W 軌道燈  
 尺寸 (mm) : L90×H160×W70  
 輸入電壓 : AC90-240V  
 光源 : **OSRAM** inside  
 輸出流明 : 400lm  
 工作壽命 : 30000 小時

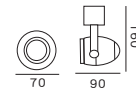

CI-5048-4



CI-5048-5

**CI-5048-4 1,125**

10W 軌道燈  
 尺寸 (mm) : L140×H240×W40  
 輸入電壓 : AC90-240V  
 光源 : **CREE** inside  
 輸出流明 : 700lm  
 工作壽命 : 30000 小時

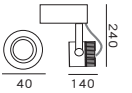

**CI-5048-5 1,125**

10W 軌道燈  
 尺寸 (mm) : L140×H240×W40  
 輸入電壓 : AC90-240V  
 光源 : **CREE** inside  
 輸出流明 : 700lm  
 工作壽命 : 30000 小時

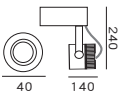





### CI-5049-1 1,690

AR-111 15W 軌道燈  
 尺寸(mm) : L125×H210×W115  
 輸入電壓 : AC90-240V  
 光源 : **OSRAM** Inside  
 輸出流明 : 1300lm  
 工作壽命 : 30000 小時

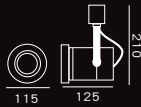

### CI-5049-2 1,690

AR-111 15W 軌道燈  
 尺寸(mm) : L125×H210×W115  
 輸入電壓 : AC90-240V  
 光源 : **OSRAM** Inside  
 輸出流明 : 1300lm  
 工作壽命 : 30000 小時

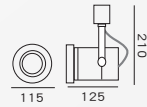

### CI-5049-3 1,770

AR-111 15W 軌道燈  
 尺寸(mm) : L70×H220×W140  
 輸入電壓 : AC90-240V  
 光源 : **OSRAM** Inside  
 輸出流明 : 1300lm  
 工作壽命 : 30000 小時



### CI-5049-4 1,770

AR-111 15W 軌道燈  
 尺寸(mm) : L70×H220×W140  
 輸入電壓 : AC90-240V  
 光源 : **OSRAM** Inside  
 輸出流明 : 1300lm  
 工作壽命 : 30000 小時

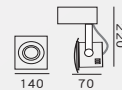

### SL-865-OSRAM

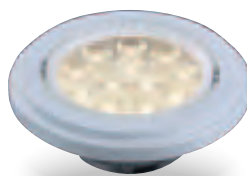

規格 : AR-111 LED 燈泡  
 消耗功率 : 15W  
 LED : **OSRAM** Inside  
 輸入電壓 : AC 90-240V  
 輸出流明 : 1300lm  
 顏色 : W/WW  
 演色性 CRI:84  
 出光角度 : 25° 45°  
 工作壽命 : 30,000 小時  
 材質 : 鋁鍍片  
 尺寸 (mm) : φ 111\*45

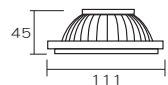

# SPOT LIGHT

High efficiency high energy-saving





**SL-866-OSRAM**

規格: PAR-30 LED 燈泡  
 消耗功率: 15W  
 LED: **OSRAM** Inside  
 輸入電壓: AC 90-240V  
 輸出流明: 1300lm  
 顏色: W/WW  
 演色性 CRI: 84  
 出光角度: 25°  
 工作壽命: 30,000 小時  
 材質: 鋁鍍片  
 尺寸 (mm): φ 95\*105





**CI-5050-1 2,030**

PAR-30 15W 軌道燈  
 尺寸: L110mm W160mm H260mm  
 光源: **OSRAM** inside  
 流明: 1300lm  
 材質: 鋁材 粉體烤漆





**CI-5050-2 1,730**

PAR-30 15W 軌道燈  
 尺寸: L98mm W127mm H207mm  
 光源: **OSRAM** inside  
 流明: 1300lm  
 材質: 鋁材 粉體烤漆

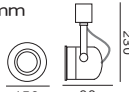

**CI-5050-3 1,880**

AR-111 15W 軌道燈  
 尺寸: L150mm W90mm H230mm  
 光源: **OSRAM** inside  
 流明: 1300lm  
 材質: 鋁材 粉體烤漆



**CI-5050-4 2,030**

PAR-30 15W 軌道燈  
 尺寸: L120mm W170mm H260mm  
 光源: **OSRAM** inside  
 流明: 1300lm  
 材質: 鋁材 粉體烤漆



**CI-5050-5 1,730**

PAR-30 15W 軌道燈  
 尺寸: L98mm W127mm H207mm  
 光源: **OSRAM** inside  
 流明: 1300lm  
 材質: 鋁材 粉體烤漆



**CI-5050-6 1,880**

AR-111 15W 軌道燈  
 尺寸: L150mm W90mm H230mm  
 光源: **OSRAM** inside  
 流明: 1300lm  
 材質: 鋁材 粉體烤漆





CI-5051-1



CI-5051-2



CI-5051-3



CI-5051-4



### CI-5051-1 1,190

COB 10W 軌道燈  
 尺寸(mm) : L80×H210×W90  
 輸入電壓 : AC90-240V  
 光源 : **CREE** inside  
 輸出流明 : 700lm  
 工作壽命 : 30000 小時

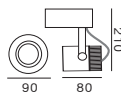

### CI-5051-2 750

10W 軌道燈  
 尺寸(mm) : L45×H180×W75  
 輸入電壓 : AC90-240V  
 光源 : **NICHIA** inside  
 輸出流明 : 700lm  
 工作壽命 : 30000 小時

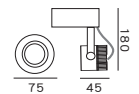

### CI-5051-3 1,130

COB 15W 軌道燈  
 尺寸(mm) : L120×H200×W90  
 輸入電壓 : AC90-240V  
 光源 : **CREE** inside  
 輸出流明 : 1300lm  
 工作壽命 : 30000 小時

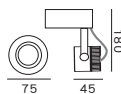

### CI-5051-4 750

10W 軌道燈  
 尺寸(mm) : L45×H180×W75  
 輸入電壓 : AC90-240V  
 光源 : **NICHIA** inside  
 輸出流明 : 700lm  
 工作壽命 : 30000 小時

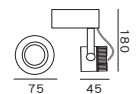

# SPOT LIGHT

High efficiency high energy-saving



## CI-5052-1 1,080

AR-111 10W 軌道燈  
 尺寸(mm) : L140×H240×W140  
 輸入電壓 : AC90-240V  
 光源 : **NICHIA** inside  
 輸出流明 : 700lm  
 工作壽命 : 30000 小時

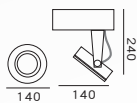

## CI-5052-2 1,950

AR-111 COB 15W 軌道燈  
 尺寸(mm) : L140×H240×W140  
 輸入電壓 : AC90-240V  
 光源 : **CREE** inside  
 輸出流明 : 1300lm  
 工作壽命 : 30000 小時

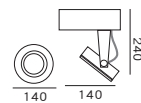

## CI-5052-3 1,580

AR-111 15W 軌道燈  
 尺寸(mm) : L140×H240×W140  
 輸入電壓 : AC90-240V  
 光源 : **OSRAM** inside  
 輸出流明 : 1300lm  
 工作壽命 : 30000 小時

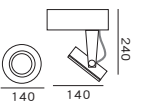

## CI-5052-4 1,080

AR-111 10W 軌道燈  
 尺寸(mm) : L140×H240×W140  
 輸入電壓 : AC90-240V  
 光源 : **NICHIA** inside  
 輸出流明 : 700lm  
 工作壽命 : 30000 小時

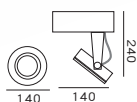

## CI-5052-5 1,950

AR-111 COB 15W 軌道燈  
 尺寸(mm) : L140×H240×W140  
 輸入電壓 : AC90-240V  
 光源 : **CREE** inside  
 輸出流明 : 1300lm  
 工作壽命 : 30000 小時

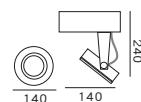

## CI-5052-6 1,580

AR-111 15W 軌道燈  
 尺寸(mm) : L140×H240×W140  
 輸入電壓 : AC90-240V  
 光源 : **OSRAM** inside  
 輸出流明 : 1300lm  
 工作壽命 : 30000 小時

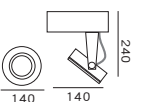

When considering ceiling lighting, Recessed Lighting has become a very popular option. Used frequently in home remodels and in new home construction recessed lighting works great in almost any location in the home. Versatile and available in a multitude of sizes and lamp combinations recessed ceiling lighting is an affordable and attractive solution for whatever your application. Before buying be sure to read our blog to learn more about designing with recessed lighting and you will also want to read our article Recessed Lighting Tips and General Guidelines.

## DOWN LIGHT

Recessed Lighting has become a very popular option

002

## SPOT LIGHT

Used frequently in home remodels

052

## BOXLIGHT

Versatile and available in a multitude of sizes and lamp

054

## WALL SPOT

recessed ceiling lighting is an affordable and attractive solution

059

## BOXLIGHT

Lighting Tips and General Guidelines

060

## BRACKET

attractive solution for whatever application

062

## PANDENT

Lighting has become a very popular option

068

## CEILING

more about designing with recessed

077

# BOX LIGHT

High efficiency high energy-saving

壁掛式

# BRACKET



CI-5054-1



CI-5054-2



## CI-5054-1 4,270

30W 壁燈  
尺寸：W150mm H160mm  
輸入電壓：AC90~240V  
光源：NICHIA inside  
流明：4000lm  
材質：鋼板沖壓成型



CI-5054-3

## CI-5054-2 7,890

COB 30W×2 壁燈  
尺寸：W335mm H160mm  
輸入電壓：AC90~240V  
光源：CREE inside  
流明：6000lm  
材質：鋼板沖壓成型



## CI-5054-3 11,700

COB 30W×3 壁燈  
尺寸：W465mm H160mm  
輸入電壓：AC90~240V  
光源：CREE inside  
流明：9000lm  
材質：鋼板沖壓成型



## CI-5055-1 4,270

30W 方型吸頂燈  
尺寸：W150mm H160mm  
輸入電壓：AC90-240V  
光源：NICHIA inside  
流明：4000lm  
材質：鋼板沖壓成型

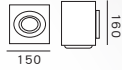

CI-5055-1

# CEILING

吸頂式

## CI-5055-2 7,890

COB 30W×2 方型吸頂燈  
尺寸：W335mm H160mm  
光源：CREE inside  
流明：6000lm  
材質：鋼板沖壓成型



CI-5055-2

## CI-5055-3 11,700

COB 30W×3 方型吸頂燈  
尺寸：W465mm H160mm  
光源：CREE inside  
流明：9000lm  
材質：鋼板沖壓成型



CI-5055-3

# BOX LIGHT

High efficiency high energy-saving

軌道式

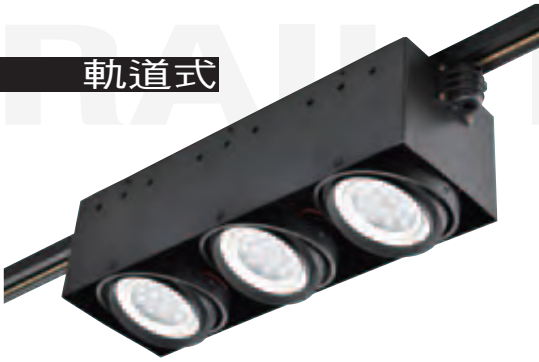

**CI-5056-1 7,280**

AR-111 15W×3 軌道燈  
尺寸：W440mm H145mm  
輸入電壓：AC90~240V  
光源：**OSRAM** inside  
流明：3900lm  
材質：鋼板沖壓成型

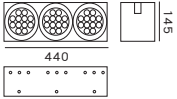

**CI-5056-4 8,400**

COB 15W×3 軌道燈  
尺寸：W440mm H145mm  
輸入電壓：AC90~240V  
光源：**CREE** inside  
流明：3900lm  
材質：鋼板沖壓成型

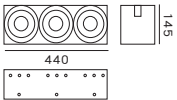

**CI-5056-7 5,780**

AR-111 10W×3 軌道燈  
尺寸：W440mm H145mm  
輸入電壓：AC90~240V  
光源：**NICHIA** inside  
流明：2100lm  
材質：鋼板沖壓成型漆

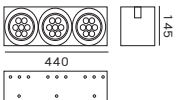

**CI-5056-2 4,850**

AR-111 15W×2 軌道燈  
尺寸：W298mm H145mm  
輸入電壓：AC90~240V  
光源：**OSRAM** inside  
流明：2600lm  
材質：鋼板沖壓成型

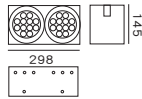

**CI-5056-5 5,600**

COB 15W×2 軌道燈  
尺寸：W298mm H145mm  
輸入電壓：AC90~240V  
光源：**CREE** inside  
流明：2600lm  
材質：鋼板沖壓成型

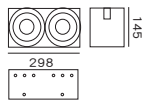

**CI-5056-8 3,850**

AR-111 10W×2 軌道燈  
尺寸：W298mm H145mm  
輸入電壓：AC90~240V  
光源：**NICHIA** inside  
流明：1400lm  
材質：鋼板沖壓成型

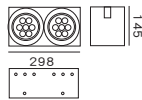

**CI-5056-3 2,430**

AR-111 15W 軌道燈  
尺寸：W157mm H145mm  
輸入電壓：AC90~240V  
光源：**OSRAM** inside  
流明：1300lm  
材質：鋼板沖壓成型

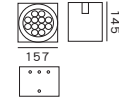

**CI-5056-6 2,800**

COB 15W 軌道燈  
尺寸：W157mm H145mm  
輸入電壓：AC90~240V  
光源：**CREE** inside  
流明：1300lm  
材質：鋼板沖壓成型

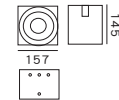

**CI-5056-9 1,930**

AR-111 10W 軌道燈  
尺寸：W157mm H145mm  
輸入電壓：AC90~240V  
光源：**NICHIA** inside  
流明：700lm  
材質：鋼板沖壓成型

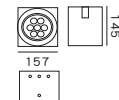





CI-5057-1



CI-5057-2



CI-5057-3

# Embed

嵌入式

## CI-5057-1 2,620

MR-16 6W×3 嵌燈  
 尺寸：L345mm W135mm H110mm  
 輸入電壓：AC90-240V  
 光源：NICHIA inside  
 流明：1200lm  
 嵌入孔：110×320mm  
 材質：鋁框 粉體烤漆

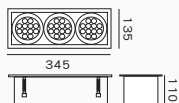

嵌入孔  
110×320  
mm

## CI-5057-2 1,750

MR-16 6W×2 嵌燈  
 尺寸：L240mm W135mm H110mm  
 輸入電壓：AC90-240V  
 光源：NICHIA inside  
 流明：800lm  
 嵌入孔：110×220mm  
 材質：鋁框 粉體烤漆

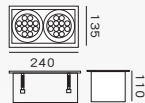

嵌入孔  
110×220  
mm

## CI-5057-3 880

MR-16 6W 嵌燈  
 尺寸：L135mm W135mm H110mm  
 輸入電壓：AC90-240V  
 光源：NICHIA inside  
 流明：400lm  
 嵌入孔：110×110mm  
 材質：鋁框 粉體烤漆

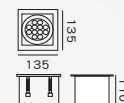

嵌入孔  
110×110  
mm



## CI-5057-4 1,050

AR-111 10W 嵌燈  
 尺寸：L205mm W205mm H90mm  
 輸入電壓：AC90-240V  
 光源：NICHIA inside  
 流明：700lm  
 嵌入孔：165×165mm  
 材質：鋁框 粉體烤漆

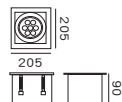

嵌入孔  
165×165  
mm



## CI-5057-5 2,050

AR-111 15W 嵌燈  
 尺寸：L205mm W205mm H90mm  
 輸入電壓：AC90-240V  
 光源：OSRAM inside  
 流明：1300lm  
 嵌入孔：165×165mm  
 材質：鋁框 粉體烤漆

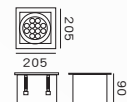

嵌入孔  
165×165  
mm



## CI-5057-6 2,050

COB AR-111 15W 嵌燈  
 尺寸：L205mm W205mm H90mm  
 輸入電壓：AC90-240V  
 光源：CREE inside  
 流明：1300lm  
 嵌入孔：165×165mm  
 材質：鋁框 粉體烤漆

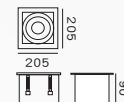

嵌入孔  
165×165  
mm

# BOX LIGHT

High efficiency high energy-saving

嵌入式



CI-5058-1

CI-5058-2

CI-5058-3

## CI-5058-1 4,320

10W×3 嵌燈  
 尺寸：L322mm W114mm H95mm  
 輸入電壓：AC90-240V  
 光源：**NICHIA** inside  
 流明：2100lm  
 嵌入孔：115×323mm  
 材質：鋼鐵製品 電鍍漆

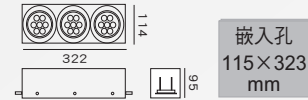

嵌入孔  
115×323  
mm

## CI-5058-2 2,880

10W×2 嵌燈  
 尺寸：L218mm W114mm H95mm  
 輸入電壓：AC90-240V  
 光源：**NICHIA** inside  
 流明：1400lm  
 嵌入孔：115×219mm  
 材質：鋼鐵製品 電鍍漆

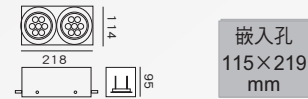

嵌入孔  
115×219  
mm

## CI-5058-3 1,440

10W 嵌燈  
 尺寸：L114mm W114mm H95mm  
 輸入電壓：AC90-240V  
 光源：**NICHIA** inside  
 流明：700lm  
 嵌入孔：115×115mm  
 材質：鋼鐵製品 電鍍漆

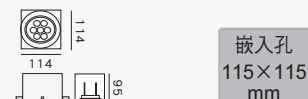

嵌入孔  
115×115  
mm

## CI-5058-4 5,440

COB 10W×3 嵌燈  
 尺寸：L470mm W190mm H85mm  
 輸入電壓：AC90-240V  
 光源：**CREE** inside  
 流明：2100lm  
 嵌入孔：130×370mm  
 材質：鋁框 粉體烤漆

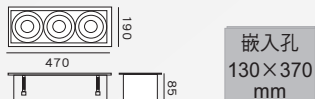

嵌入孔  
130×370  
mm

## CI-5058-5 3,690

COB 10W×2 嵌燈  
 尺寸：L352mm W190mm H85mm  
 輸入電壓：AC90-240V  
 光源：**CREE** inside  
 流明：1400lm  
 嵌入孔：130×260mm  
 材質：鋁框 粉體烤漆



嵌入孔  
130×260  
mm

## CI-5058-6 2,130

COB 10W 嵌燈  
 尺寸：L150mm W150mm H60mm  
 輸入電壓：AC90-240V  
 光源：**CREE** inside  
 流明：700lm  
 嵌入孔：120×120mm  
 材質：鋁框 粉體烤漆



嵌入孔  
120×120  
mm



CI-5058-4

CI-5058-5

CI-5058-6



CI-5059-1



CI-5059-3



CI-5059-2

### CI-5059-1 1,680

10W 嵌燈  
 尺寸：L150mm W150mm H60mm  
 輸入電壓：AC90~240V  
 光源：NICHIA inside  
 流明：700lm  
 嵌入孔：120×120mm  
 材質：鋁框

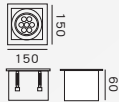

嵌入孔  
 120×120  
 mm

### CI-5059-2 3,090

10W×2 嵌燈  
 尺寸：L275mm W145mm H85mm  
 輸入電壓：AC90~240V  
 光源：NICHIA inside  
 流明：1400lm  
 嵌入孔：120×320mm  
 材質：鋁框

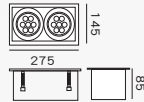

嵌入孔  
 130×260  
 mm

### CI-5059-3 4,350

10W×3 嵌燈  
 尺寸：L390mm W147mm H95mm  
 輸入電壓：AC90~240V  
 光源：NICHIA inside  
 流明：2100lm  
 嵌入孔：120×470mm  
 材質：鋁框

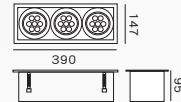

嵌入孔  
 130×370  
 mm



CI-5059-4  
 CI-5059-5

### CI-5059-4 (白) 1,570 CI-5059-5 (黑) 1,570

10W 吸頂燈  
 尺寸：φ90mm H100mm  
 輸入電壓：AC90~240V  
 光源：NICHIA inside  
 流明：700lm  
 材質：鋁製品



# BOX LIGHT

High efficiency high energy-saving

## 無邊框嵌入式



**CI-5060-1 4,320**

AR-111 10W×3 嵌燈  
尺寸：L460mm W160mm H90mm  
輸入電壓：AC90~240V  
光源：NICHIA inside  
流明：2100lm  
嵌入孔：161×461mm  
材質：鋼鐵製品 電鍍漆

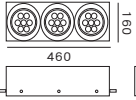

嵌入孔  
161×461  
mm



**CI-5060-2 2,880**

AR-111 10W×2 嵌燈  
尺寸：L310mm W160mm H90mm  
輸入電壓：AC90~240V  
光源：NICHIA inside  
流明：1400lm  
嵌入孔：161×311mm  
材質：鋼鐵製品 電鍍漆

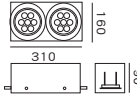

嵌入孔  
161×311  
mm



**CI-5060-3 1,440**

AR-111 10W 嵌燈  
尺寸：L160mm W160mm H90mm  
輸入電壓：AC90~240V  
光源：NICHIA inside  
流明：700lm  
嵌入孔：161×161mm  
材質：鋼鐵製品 電鍍漆

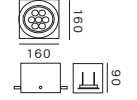

嵌入孔  
161×161  
mm



**CI-5060-4 5,820**

AR-111 15W×3 嵌燈  
尺寸：L460mm W160mm H90mm  
輸入電壓：AC90~240V  
光源：OSRAM inside  
流明：3900lm  
嵌入孔：161×461mm  
材質：鋼鐵製品 電鍍漆

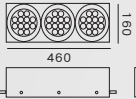

嵌入孔  
161×461  
mm



**CI-5060-5 3,880**

AR-111 15W×2 嵌燈  
尺寸：L310mm W160mm H90mm  
輸入電壓：AC90~240V  
光源：OSRAM inside  
流明：2600lm  
嵌入孔：161×311mm  
材質：鋼鐵製品 電鍍漆

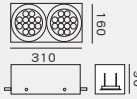

嵌入孔  
161×311  
mm



**CI-5060-6 1,940**

AR-111 15W 嵌燈  
尺寸：L160mm W160mm H90mm  
輸入電壓：AC90~240V  
光源：OSRAM inside  
流明：1300lm  
嵌入孔：161×161mm  
材質：鋼鐵製品 電鍍漆

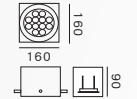

嵌入孔  
161×161  
mm



**CI-5060-7 5,820**

AR-111 15W×3 嵌燈  
尺寸：L460mm W160mm H90mm  
輸入電壓：AC90~240V  
光源：CREE inside  
流明：3900lm  
嵌入孔：161×461mm  
材質：鋼鐵製品 電鍍漆

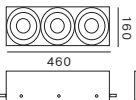

嵌入孔  
161×461  
mm



**CI-5060-8 3,880**

AR-111 15W×2 嵌燈  
尺寸：L310mm W160mm H90mm  
輸入電壓：AC90~240V  
光源：CREE inside  
流明：2600lm  
嵌入孔：161×311mm  
材質：鋼鐵製品 電鍍漆

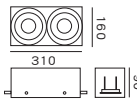

嵌入孔  
161×311  
mm



**CI-5060-9 1,940**

AR-111 15W 嵌燈  
尺寸：L160mm W160mm H90mm  
輸入電壓：AC90~240V  
光源：CREE inside  
流明：1300lm  
嵌入孔：161×161mm  
材質：鋼鐵製品 電鍍漆

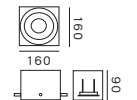

嵌入孔  
161×161  
mm

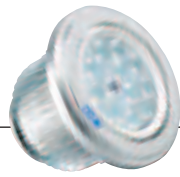

## AR-111 30W



### CI-5061-1 13,320

AR-111 30W×3 嵌燈  
 尺寸：L465mm W150mm H160mm  
 輸入電壓：AC90~240V  
 光源：**NICHIA** inside  
 流明：12000lm  
 嵌入孔：151×466mm  
 材質：鋼板沖壓成型 鋁框

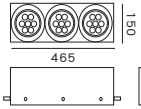

嵌入孔  
151×466  
mm

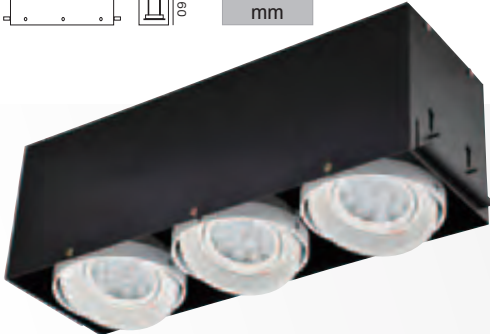

### CI-5061-4 6,940

AR-111 15W×3 嵌燈  
 尺寸：L465mm W150mm H160mm  
 輸入電壓：AC90~240V  
 光源：**OSRAM** inside  
 流明：3900lm  
 嵌入孔：151×466mm  
 材質：鋼板沖壓成型 鋁框

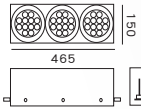

嵌入孔  
151×466  
mm

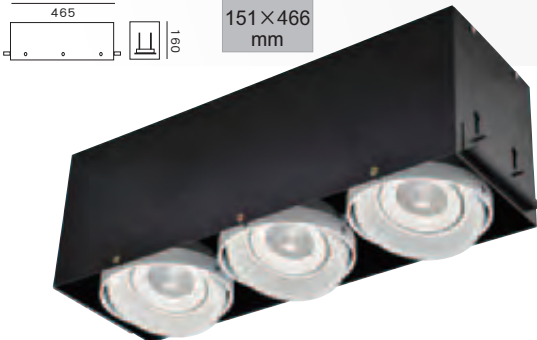

### CI-5061-7 8,070

AR-111 15W×3 嵌燈  
 尺寸：L465mm W150mm H160mm  
 輸入電壓：AC90~240V  
 光源：**CREE** inside  
 流明：3900lm  
 嵌入孔：151×466mm  
 材質：鋼板沖壓成型 鋁框

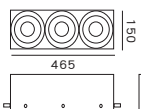

嵌入孔  
151×466  
mm



### CI-5061-2 9,130

AR-111 30W×2 嵌燈  
 尺寸：L335mm W150mm H160mm  
 輸入電壓：AC90~240V  
 光源：**NICHIA** inside  
 流明：8000lm  
 嵌入孔：151×336mm  
 材質：鋼板沖壓成型 鋁框

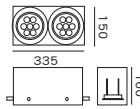

嵌入孔  
151×336  
mm



### CI-5061-5 4,880

AR-111 15W×2 嵌燈  
 尺寸：L335mm W150mm H160mm  
 輸入電壓：AC90~240V  
 光源：**OSRAM** inside  
 流明：2600lm  
 嵌入孔：151×336mm  
 材質：鋼板沖壓成型 鋁框

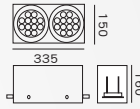

嵌入孔  
151×336  
mm



### CI-5061-8 5,630

AR-111 15W×2 嵌燈  
 尺寸：L335mm W150mm H160mm  
 輸入電壓：AC90~240V  
 光源：**CREE** inside  
 流明：2600lm  
 嵌入孔：151×336mm  
 材質：鋼板沖壓成型 鋁框

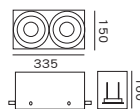

嵌入孔  
151×336  
mm



### CI-5061-3 4,750

AR-111 30W 嵌燈  
 尺寸：L150mm W150mm H160mm  
 輸入電壓：AC90~240V  
 光源：**NICHIA** inside  
 流明：4000lm  
 嵌入孔：151×151mm  
 材質：鋼板沖壓成型 鋁框

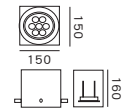

嵌入孔  
151×151  
mm



### CI-5061-6 2,630

AR-111 15W 嵌燈  
 尺寸：L150mm W150mm H160mm  
 輸入電壓：AC90~240V  
 光源：**OSRAM** inside  
 流明：1300lm  
 嵌入孔：151×151mm  
 材質：鋼板沖壓成型 鋁框

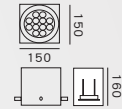

嵌入孔  
151×151  
mm



### CI-5061-9 3,000

AR-111 15W 嵌燈  
 尺寸：L150mm W150mm H160mm  
 輸入電壓：AC90~240V  
 光源：**CREE** inside  
 流明：1300lm  
 嵌入孔：151×151mm  
 材質：鋼板沖壓成型 鋁框

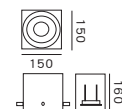

嵌入孔  
151×151  
mm

# BOX LIGHT

High efficiency high energy-saving



## CI-5062-1 3,680

AR-111 10W×3 嵌燈  
 尺寸：L474mm W176mm H50mm  
 輸入電壓：AC90~240V  
 光源：NICHIA inside  
 流明：2100lm  
 嵌入孔：160×460mm  
 材質：鋁框 粉體烤漆

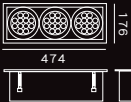

嵌入孔  
 160×460  
 mm



## CI-5062-2 2,380

AR-111 10W×2 嵌燈  
 尺寸：L328mm W176mm H50mm  
 輸入電壓：AC90~240V  
 光源：NICHIA inside  
 流明：1400lm  
 嵌入孔：160×310mm  
 材質：鋁框 粉體烤漆

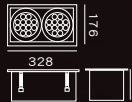

嵌入孔  
 160×310  
 mm

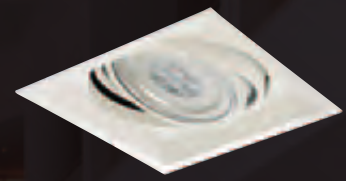

## CI-5062-3 1,300

AR-111 10W 嵌燈  
 尺寸：L176mm W176mm H50mm  
 輸入電壓：AC90~240V  
 光源：NICHIA inside  
 流明：0000lm  
 嵌入孔：160×160mm  
 材質：鋁框 粉體烤漆



嵌入孔  
 160×160  
 mm



## CI-5062-4 5,180

AR-111 15W×3 嵌燈  
 尺寸：L474mm W176mm H50mm  
 輸入電壓：AC90~240V  
 光源：OSRAM inside  
 流明：3900lm  
 嵌入孔：160×460mm  
 材質：鋁框 粉體烤漆

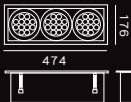

嵌入孔  
 160×460  
 mm

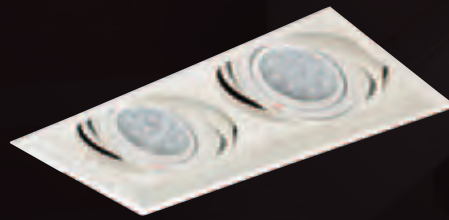

## CI-5062-5 3,380

AR-111 15W×2 嵌燈  
 尺寸：L328mm W176mm H50mm  
 輸入電壓：AC90~240V  
 光源：OSRAM inside  
 流明：2600lm  
 嵌入孔：160×310mm  
 材質：鋁框 粉體烤漆

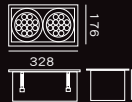

嵌入孔  
 160×310  
 mm



## CI-5062-6 1,800

AR-111 15W 嵌燈  
 尺寸：L176mm W176mm H50mm  
 輸入電壓：AC90~240V  
 光源：OSRAM inside  
 流明：0000lm  
 嵌入孔：160×160mm  
 材質：鋁框 粉體烤漆



嵌入孔  
 160×160  
 mm



## CI-5062-7 6,300

AR-111 15W×3 嵌燈  
 尺寸：L474mm W176mm H50mm  
 輸入電壓：AC90~240V  
 光源：CREE inside  
 流明：3900lm  
 嵌入孔：160×460mm  
 材質：鋁框 粉體烤漆

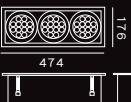

嵌入孔  
 160×460  
 mm



## CI-5062-8 4,130

AR-111 15W×2 嵌燈  
 尺寸：L328mm W176mm H50mm  
 輸入電壓：AC90~240V  
 光源：CREE inside  
 流明：2600lm  
 嵌入孔：160×310mm  
 材質：鋁框 粉體烤漆

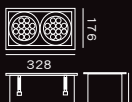

嵌入孔  
 160×310  
 mm

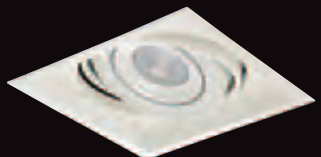

## CI-5062-9 2,180

AR-111 15W 嵌燈  
 尺寸：L176mm W176mm H50mm  
 輸入電壓：AC90~240V  
 光源：CREE inside  
 流明：0000lm  
 嵌入孔：160×160mm  
 材質：鋁框 粉體烤漆

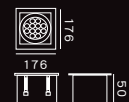

嵌入孔  
 160×160  
 mm

# WALLT LIGHT

High efficiency high energy-saving

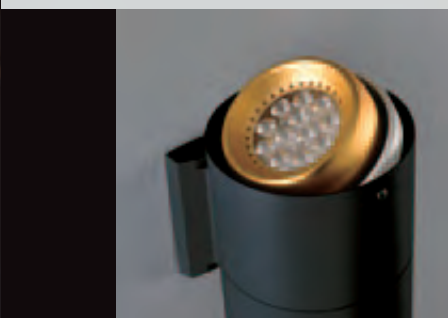

CI-5063-1



CI-5063-2



CI-5063-3

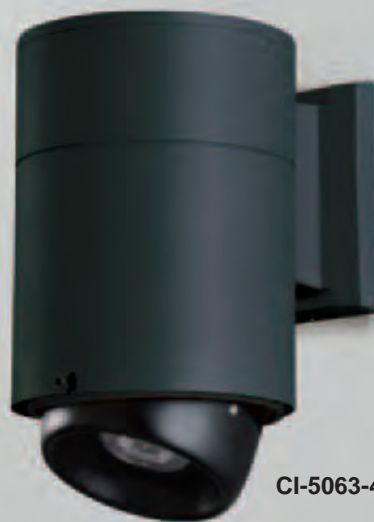

CI-5063-4

## CI-5063-1 10,440

30W×2 上下照壁燈  
尺寸：φ 145mm H335mm  
輸入電壓：AC90-240V  
光源：NICHIA inside  
流明：8000lm  
材質：鋁製品 粉體烤漆

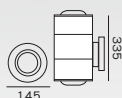

## CI-5063-2 10,440

COB 30W×2 上下照壁燈  
尺寸：φ 145mm H335mm  
輸入電壓：AC90-240V  
光源：CREE inside  
流明：6000lm  
材質：鋁製品 粉體烤漆

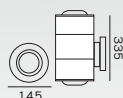

## CI-5063-3 6,250

30W 壁燈  
尺寸：φ 145mm H230mm  
輸入電壓：AC90-240V  
光源：NICHIA inside  
流明：4000lm  
材質：鋁製品 粉體烤漆

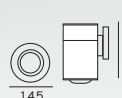

## CI-5063-4 6,250

COB 30W 壁燈  
尺寸：φ 145mm H230mm  
輸入電壓：AC90-240V  
光源：CREE inside  
流明：3000lm  
材質：鋁製品 粉體烤漆

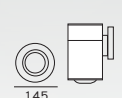

# CEILING

High efficiency high energy-saving



## CI-5064-1 1,990

AR-111 10W 吸頂燈  
尺寸：φ 135mm H170mm  
輸入電壓：AC90-240V  
光源：**NICHIA** inside  
流明：700lm  
材質：鋁製品 粉體烤漆



## CI-5064-2 2,870

AR-111 COB 15W 吸頂燈  
尺寸：φ 135mm H170mm  
輸入電壓：AC90-240V  
光源：**CREE** inside  
流明：1300lm  
材質：鋁製品 粉體烤漆

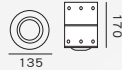

## CI-5064-3 2,490

AR-111 15W 吸頂燈  
尺寸：φ 135mm H170mm  
輸入電壓：AC90-240V  
光源：**OSRAM** inside  
流明：1300lm  
材質：鋁製品 粉體烤漆



## CI-5064-4 1,770

AR-111 10W 吸頂燈  
尺寸：φ 160mm H140mm  
輸入電壓：AC90-240V  
光源：**NICHIA** inside  
流明：700lm  
材質：鋁框 鐵筒 粉體烤漆



## CI-5064-5 2,640

AR-111 COB 15W 吸頂燈  
尺寸：φ 160mm H140mm  
輸入電壓：AC90-240V  
光源：**CREE** inside  
流明：1300lm  
材質：鋁框 鐵筒 粉體烤漆



## CI-5064-6 2,270

AR-111 15W 吸頂燈  
尺寸：φ 160mm H140mm  
輸入電壓：AC90-240V  
光源：**OSRAM** inside  
流明：1300lm  
材質：鋁框 鐵筒 粉體烤漆







### CI-5065-1 1,830

AR-111 10W 吸頂燈  
尺寸：φ 142mm H110mm  
輸入電壓：AC90~240V  
光源：NICHIA inside  
流明：700lm  
材質：鋁製品 粉體烤漆



### CI-5065-2 2,330

AR-111 15W 吸頂燈  
尺寸：φ 142mm H110mm  
輸入電壓：AC90~240V  
光源：OSRAM inside  
流明：1300lm  
材質：鋁製品 粉體烤漆



### CI-5065-3 2,710

AR-111 COB 15W 吸頂燈  
尺寸：φ 160mm H140mm  
輸入電壓：AC90~240V  
光源：CREE inside  
流明：1300lm  
材質：鋁框 鐵筒 粉體烤漆



### CI-5065-4 1,670

COB 20W 吸頂燈  
尺寸：φ 140mm H180mm  
輸入電壓：AC90~240V  
光源：CREE inside  
流明：3000lm  
材質：鋁製品 粉體烤漆



### CI-5065-5 2,270

AR-111 15W 吸頂燈  
尺寸：φ 160mm H140mm  
輸入電壓：AC90~240V  
光源：OSRAM inside  
流明：1300lm  
材質：鋁框 鐵筒 粉體烤漆



### CI-5065-6 2,640

AR-111 15W 吸頂燈  
尺寸：φ 142mm H110mm  
輸入電壓：AC90~240V  
光源：CREE inside  
流明：1300lm  
材質：鋁製品 粉體烤漆



# CEILING

High efficiency high energy-saving

## CI-5066-1 1,790

E27 10W 吸頂燈  
 尺寸：□ 140mm H190mm  
 輸入電壓：AC90-240V  
 光源：台製 LED  
 流明：900lm  
 材質：鐵 鋁材加工成型  
 粉體烤漆 鋁反射鏡



CI-5066-1



CI-5066-2

## CI-5066-2 1,790

E27 10W 吸頂燈  
 尺寸：□ 140mm H190mm  
 輸入電壓：AC90-240V  
 光源：台製 LED  
 流明：900lm  
 材質：鐵 鋁材加工成型  
 粉體烤漆 鋁反射鏡



## CI-5066-3 1,630

12W 吸頂燈  
 尺寸：φ 180mm H100mm  
 輸入電壓：AC90-240V  
 光源：台製 LED  
 流明：1000lm  
 材質：鋁材 粉體烤漆



## CI-5066-4 1,630

12W 吸頂燈  
 尺寸：φ 180mm H100mm  
 輸入電壓：AC90-240V  
 光源：台製 LED  
 流明：1000lm  
 材質：鋁材 粉體烤漆



## CI-5066-5 1,630

12W 吸頂燈  
 尺寸：φ 180mm H100mm  
 輸入電壓：AC90-240V  
 光源：台製 LED  
 流明：1000lm  
 材質：鋁材 粉體烤漆



## CI-5066-6 1,230

10W 吸頂燈  
 尺寸：φ 165mm H200mm  
 輸入電壓：AC90-240V  
 光源：台製 LED  
 流明：700lm  
 材質：鋁材 粉體烤漆

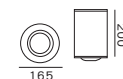



CI-5067-1



CI-5067-2



CI-5067-5



CI-5067-6



CI-5067-3



CI-5067-4

### CI-5067-1 2,140

E27 10W 壁燈  
尺寸：L150mm W100mm H160mm  
輸入電壓：AC90~240V  
光源：台製 LED  
流明：900lm  
材質：鋁材 粉體烤漆

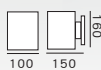

### CI-5067-3 3,630

E27 10W×2 壁燈  
尺寸：L160mm W100mm H300mm  
輸入電壓：AC90~240V  
光源：台製 LED  
流明：1800lm  
材質：鋁材 粉體烤漆

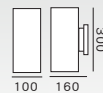

### CI-5067-5 3,490

MR16 6W×2 壁燈  
尺寸：L140mm W80mm H300mm  
輸入電壓：AC90~240V  
光源：NICHIA inside  
流明：800lm  
材質：鋁材 粉體烤漆

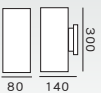

### CI-5067-2 2,140

E27 10W 壁燈  
尺寸：L150mm W100mm H160mm  
輸入電壓：AC90~240V  
光源：台製 LED  
流明：900lm  
材質：鋁材 粉體烤漆

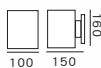

### CI-5067-4 3,630

E27 10W×2 壁燈  
尺寸：L160mm W100mm H300mm  
輸入電壓：AC90~240V  
光源：台製 LED  
流明：1800lm  
材質：鋁材 粉體烤漆

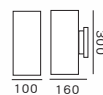

### CI-5067-6 3,490

MR16 6W×2 壁燈  
尺寸：L140mm W80mm H300mm  
輸入電壓：AC90~240V  
光源：NICHIA inside  
流明：800lm  
材質：鋁材 粉體烤漆

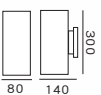

# WALL LIGHT

High efficiency high energy-saving



CI-5068-1



CI-5068-2



CI-5068-3



CI-5068-4



CI-5068-5



CI-5068-6

## CI-5068-1 2,100

MR16 6W 壁燈  
尺寸：L150mm W80mm H140mm  
輸入電壓：AC90~240V  
光源：NICHIA inside  
流明：400lm  
材質：鋁材 粉體烤漆

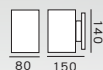

## CI-5068-3 3,630

E27 10W×2 壁燈  
尺寸：L170mm W105mm H300mm  
輸入電壓：AC90~240V  
光源：台製 LED  
流明：1800lm  
材質：鋁材 粉體烤漆



## CI-5068-5 2,940

MR16 6W 壁燈  
尺寸：L140mm W80mm H300mm  
輸入電壓：AC90~240V  
光源：NICHIA inside  
流明：400lm  
材質：鋁材 粉體烤漆

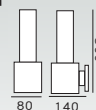

## CI-5068-2 2,100

MR16 6W 壁燈  
尺寸：L150mm W80mm H140mm  
輸入電壓：AC90~240V  
光源：NICHIA inside  
流明：400lm  
材質：鋁材 粉體烤漆

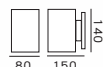

## CI-5068-4 3,630

E27 10W×2 壁燈  
尺寸：L170mm W105mm H300mm  
輸入電壓：AC90~240V  
光源：台製 LED  
流明：1800lm  
材質：鋁材 粉體烤漆



## CI-5068-6 2,940

MR16 6W 壁燈  
尺寸：L80mm W80mm H300mm  
輸入電壓：AC90~240V  
光源：NICHIA inside  
流明：400lm  
材質：鋁材 粉體烤漆

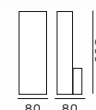



CI-5069-1



CI-5069-2



CI-5069-5



CI-5069-6

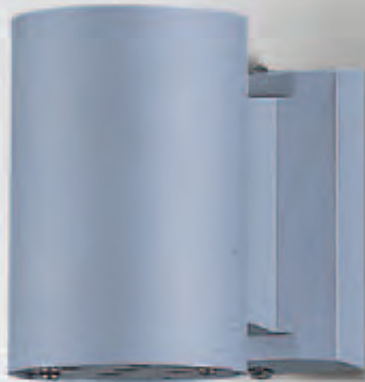

CI-5069-3



CI-5069-4

### CI-5069-1 2,140

E27 10W 壁燈  
尺寸：L150mm W105mm H170mm  
輸入電壓：AC90~240V  
光源：台製 LED  
流明：900lm  
材質：鋁材 粉體烤漆

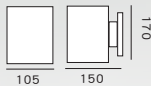

### CI-5069-3 2,100

MR16 6W 壁燈  
尺寸：L140mm W80mm H150mm  
輸入電壓：AC90~240V  
光源：NICHIA inside  
流明：400lm  
材質：鋁材 粉體烤漆



### CI-5069-5 3,490

MR16 6W×2 壁燈  
尺寸：L140mm W80mm H300mm  
輸入電壓：AC90~240V  
光源：NICHIA inside  
流明：800lm  
材質：鋁材 粉體烤漆

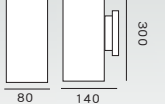

### CI-5069-2 2,140

E27 10W 壁燈  
尺寸：L150mm W105mm H170mm  
輸入電壓：AC90~240V  
光源：台製 LED  
流明：900lm  
材質：鋁材 粉體烤漆

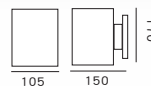

### CI-5069-4 2,100

MR16 6W 壁燈  
尺寸：L150mm W80mm H140mm  
輸入電壓：AC90~240V  
光源：NICHIA inside  
流明：400lm  
材質：鋁材 粉體烤漆

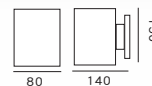

### CI-5069-6 3,490

MR16 6W×2 壁燈  
尺寸：L140mm W80mm H300mm  
輸入電壓：AC90~240V  
光源：NICHIA inside  
流明：800lm  
材質：鋁材 粉體烤漆

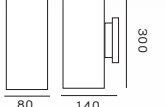

# WALL LIGHT

High efficiency high energy-saving



CI-5070-1



CI-5070-2

## CI-5070-1 1,550

E27 10W 壁燈  
尺寸：L88mm W180mm D182mm  
輸入電壓：AC90-240V  
光源：台製 LED  
流明：900lm  
材質：鋁材 粉體烤漆



## CI-5070-2 1,550

E27 10W 壁燈  
尺寸：L88mm W180mm D182mm  
輸入電壓：AC90-240V  
光源：台製 LED  
流明：900lm  
材質：鋁材 粉體烤漆

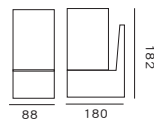

## CI-5070-3 1,550

E27 10W 壁燈  
尺寸：L153mm W180mm D190mm  
輸入電壓：AC90-240V  
光源：台製 LED  
流明：900lm  
材質：鋁材 粉體烤漆

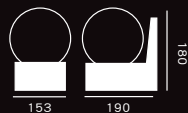

## CI-5070-4 1,550

E27 10W 壁燈  
尺寸：L153mm W180mm D190mm  
輸入電壓：AC90-240V  
光源：台製 LED  
流明：900lm  
材質：鋁材 粉體烤漆



CI-5070-3



CI-5070-4



CI-5071-1



CI-5071-2



CI-5071-3



CI-5071-4

### CI-5071-1 3,380

E27 10W 壁燈  
 尺寸：D300mm H300mm W250mm  
 輸入電壓：AC90~240V  
 光源：台製 LED  
 流明：900lm  
 嵌入孔：115mm  
 材質：鋁材 粉體烤漆

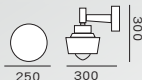

### CI-5071-2 5,250

E27 10W 壁燈  
 尺寸：D300mm H300mm W250mm  
 輸入電壓：AC90~240V  
 光源：台製 LED  
 流明：900lm  
 嵌入孔：115mm  
 材質：鋁材 粉體烤漆

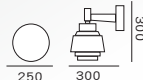

### CI-5071-3 3,380

E27 10W 壁燈  
 尺寸：D300mm H300mm W250mm  
 輸入電壓：AC90~240V  
 光源：台製 LED  
 流明：900lm  
 嵌入孔：115mm  
 材質：鋁材 粉體烤漆

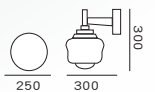

### CI-5071-4 3,000

E27 10W 壁燈  
 尺寸：D250mm H250mm W200mm  
 輸入電壓：AC90~240V  
 光源：台製 LED  
 流明：900lm  
 嵌入孔：115mm  
 材質：鋁材 粉體烤漆

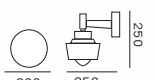



CI-5072-1



CI-5072-2



CI-5072-3



CI-5072-4

**CI-5072-1 3,380**

E27 10W 吊燈  
尺寸：W200mm H250mm  
輸入電壓：AC90-240V  
光源：台製 LED  
材質：白玉玻璃

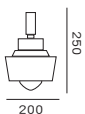

**CI-5072-2 5,250**

E27 10W 吊燈  
尺寸：W250mm H280mm  
輸入電壓：AC90-240V  
光源：台製 LED  
材質：白玉玻璃

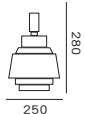

**CI-5072-3 3,380**

E27 10W 吊燈  
尺寸：W250mm H280mm  
輸入電壓：AC90-240V  
光源：台製 LED  
材質：白玉玻璃



**CI-5072-4 3,000**

E27 10W 吊燈  
尺寸：W200mm H250mm  
輸入電壓：AC90-240V  
光源：台製 LED  
材質：白玉玻璃

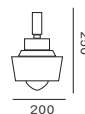





## 可調光 / 調色温 吸頂燈



附遙控器

CI-5073-1 9,720

尺寸：W560mm H127mm  
光源：LED50W  
可調光 / 調色温（附遙控器）  
材質：塑料燈罩



# CEILING

High efficiency high energy-saving

**CI-5074-1 1,750**  
**CI-5074-5 2,250** 感應式

12W 吸頂燈  
 尺寸：φ 260mm H110mm  
 輸入電壓：AC90-240V  
 光源：台製 LED  
 流明：1000lm  
 材質：白玉玻璃



CI-5074-1

**CI-5074-2 1,650**  
**CI-5074-6 2,150** 感應式

12W 吸頂燈  
 尺寸：φ 260mm H100mm  
 輸入電壓：AC90-240V  
 光源：台製 LED  
 流明：1000lm  
 材質：白玉玻璃

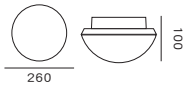

CI-5074-2

**CI-5074-3 1,650**  
**CI-5074-7 2,150** 感應式

12W 吸頂燈  
 尺寸：φ 260mm H100mm  
 輸入電壓：AC90-240V  
 光源：台製 LED  
 流明：1000lm  
 材質：白玉玻璃

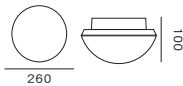

CI-5074-3

**CI-5074-4 1,650**  
**CI-5074-8 2,150** 感應式

12W 吸頂燈  
 尺寸：φ 260mm H100mm  
 輸入電壓：AC90-240V  
 光源：台製 LED  
 流明：1000lm  
 材質：白玉玻璃



CI-5074-4

**CI-5075-1 1,950**  
**CI-5075-4 2,450** 感應式

18W 吸頂燈  
尺寸：φ 500mm H100mm  
輸入電壓：AC90-240V  
光源：台製 LED  
流明：1600lm  
材質：雲彩玻璃

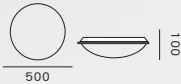

CI-5075-1

**CI-5075-2 1,450**  
**CI-5075-5 1,950** 感應式

12W 吸頂燈  
尺寸：φ 260mm H100mm  
輸入電壓：AC90-240V  
光源：台製 LED  
流明：1000lm  
材質：雲彩玻璃



CI-5075-2



CI-5075-3

**CI-5074-3 1,630**  
**CI-5074-6 2,130** 感應式

12W 吸頂燈  
尺寸：φ 260mm H110mm  
輸入電壓：AC90-240V  
光源：台製 LED  
流明：1000lm  
材質：塑膠 PC 罩



# CEILING

High efficiency high energy-saving



CI-5076-1



CI-5076-2

## CI-5076-1 4,000

36W 吸頂燈  
尺寸：φ 500mm H100mm  
輸入電壓：AC90~240V  
光源：台製 LED  
流明：3000lm  
材質：塑膠 PC 罩

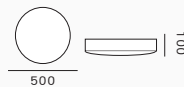

## CI-5076-2 4,000

36W 吸頂燈  
尺寸：φ 500mm H100mm  
輸入電壓：AC90~240V  
光源：台製 LED  
流明：3000lm  
材質：塑膠 PC 罩

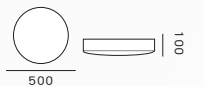

**CI-5077-1 1,480**  
**CI-5077-5 1,980** 感應式

18W 吸頂燈  
 尺寸：φ 260mm H110mm  
 輸入電壓：AC90-240V  
 光源：台製 LED  
 流明：1500lm  
 材質：塑膠 PC 罩



**CI-5077-2 1,250**  
**CI-5077-6 1,750** 感應式

12W 吸頂燈  
 尺寸：φ 260mm H70mm  
 輸入電壓：AC90-240V  
 光源：台製 LED  
 流明：1000lm  
 材質：塑膠 PC 罩



CI-5077-1

**CI-5077-3 1,250**  
**CI-5077-7 1,750** 感應式

12W 吸頂燈  
 尺寸：φ 260mm H88mm  
 輸入電壓：AC90-240V  
 光源：台製 LED  
 流明：1000lm  
 材質：塑膠 PC 罩



**CI-5077-4 1,550**  
**CI-5077-8 2,050** 感應式

18W 吸頂燈  
 尺寸：φ 320mm H90mm  
 輸入電壓：AC90-240V  
 光源：台製 LED  
 流明：1500lm  
 材質：塑膠 PC 罩



CI-5077-2



CI-5077-3



CI-5077-4



# CEILING

High efficiency high energy-saving

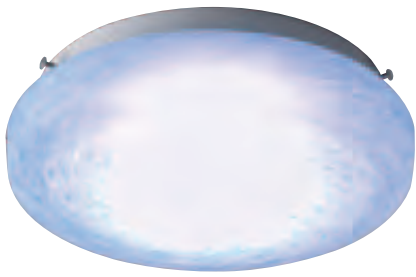

**CI-5078-1 2,180**  
**CI-5078-9 2,680** 感應式

18W 吸頂燈  
 尺寸：φ 260mm H90mm  
 輸入電壓：AC90~240V  
 光源：台製 LED  
 流明：1500lm  
 材質：鋁材 玻璃

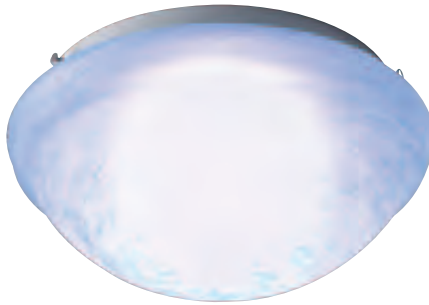
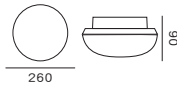

**CI-5078-2 2,230**  
**CI-5078-10 2,730** 感應式

18W 吸頂燈  
 尺寸：φ 280mm H140mm  
 輸入電壓：AC90~240V  
 光源：台製 LED  
 流明：1500lm  
 材質：鋁材 玻璃

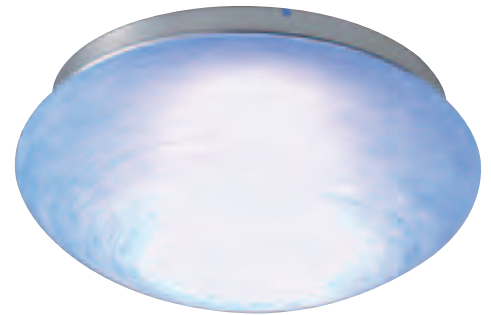
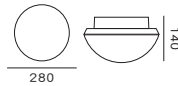

**CI-5078-3 2,530**  
**CI-5078-11 3,030** 感應式

18W 吸頂燈  
 尺寸：φ 300mm H140mm  
 輸入電壓：AC90~240V  
 光源：台製 LED  
 流明：1500lm  
 材質：鋁材 玻璃



CI-5078-4  
 CI-5078-12



CI-5078-5  
 CI-5078-13

**CI-5078-4 2,530**  
**CI-5078-12 3,030** 感應式

18W 吸頂燈  
 尺寸：φ 300mm H140mm  
 輸入電壓：AC90~240V  
 光源：台製 LED  
 流明：1500lm  
 材質：鋁材 玻璃



**CI-5078-5 2,530**  
**CI-5078-13 3,030** 感應式

18W 吸頂燈  
 尺寸：φ 300mm H145mm  
 輸入電壓：AC90~240V  
 光源：台製 LED  
 流明：1500lm  
 材質：鋁材 玻璃

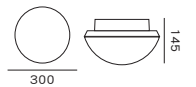

**CI-5078-6 1,880**  
**CI-5078-14 2,380** 感應式

18W 吸頂燈  
 尺寸：φ 230mm H90mm  
 輸入電壓：AC90~240V  
 光源：台製 LED  
 流明：1500lm  
 材質：鋁材 玻璃



**CI-5078-7 1,480**  
**CI-5078-15 1,980** 感應式

18W 吸頂燈  
 尺寸：φ 230mm H90mm  
 輸入電壓：AC90~240V  
 光源：台製 LED  
 流明：1500lm  
 材質：鋁材 玻璃



**CI-5078-8 1,730**  
**CI-5078-16 2,230** 感應式

18W 吸頂燈  
 尺寸：φ 230mm H90mm  
 輸入電壓：AC90~240V  
 光源：台製 LED  
 流明：1500lm  
 材質：鋁材 玻璃



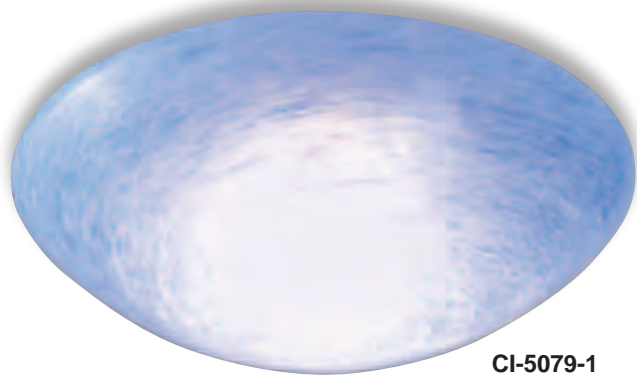

CI-5079-1

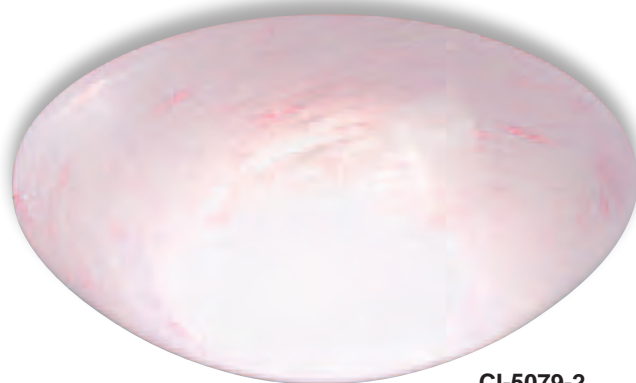

CI-5079-2



CI-5079-3



CI-5079-4

**CI-5079-1 4,200**

18W×2 吸頂燈  
尺寸：φ 380mm H160mm  
輸入電壓：AC90~240V  
光源：台製 LED  
流明：3000lm  
材質：鋁材 玻璃

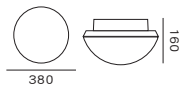

**CI-5079-2 4,200**

18W×2 吸頂燈  
尺寸：φ 380mm H160mm  
輸入電壓：AC90~240V  
光源：台製 LED  
流明：3000lm  
材質：鋁材 玻璃

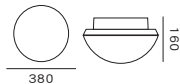

**CI-5079-3 4,200**

18W×2 吸頂燈  
尺寸：φ 380mm H160mm  
輸入電壓：AC90~240V  
光源：台製 LED  
流明：3000lm  
材質：鋁材 玻璃

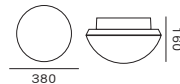

**CI-5079-4 3,950**

18W×2 吸頂燈  
尺寸：φ 380mm H160mm  
輸入電壓：AC90~240V  
光源：台製 LED  
流明：3000lm  
材質：鋁材 玻璃

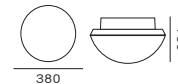

CI-5079-5  
CI-5079-7

**CI-5079-5 2,230**  
**CI-5079-7 2,730** 感應式

18W 吸頂燈  
尺寸：φ 280mm H140mm  
輸入電壓：AC90~240V  
光源：台製 LED  
流明：1500lm  
材質：鋁材 玻璃



**CI-5079-6 2,180**  
**CI-5079-8 2,680** 感應式

18W 吸頂燈  
尺寸：φ 260mm H90mm  
輸入電壓：AC90~240V  
光源：台製 LED  
流明：1500lm  
材質：鋁材 玻璃

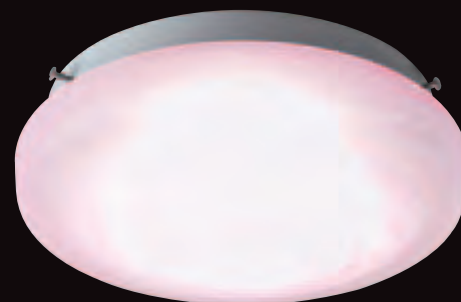

CI-5079-6  
CI-5079-8

# CEILING

High efficiency high energy-saving



CI-5080-1



CI-5080-2



CI-5080-3



CI-5080-4

## CI-5080-1 3,300

18W×3 吸頂燈  
 尺寸：φ 500mm H140mm  
 輸入電壓：AC90~240V  
 光源：台製 LED  
 流明：4500lm  
 材質：鋁材 玻璃



## CI-5080-2 2,380

12W×3 吸頂燈  
 尺寸：φ 400mm H130mm  
 輸入電壓：AC90~240V  
 光源：台製 LED  
 流明：3000lm  
 材質：鋁材 玻璃

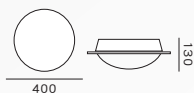

## CI-5080-3 3,430

18W×3 吸頂燈  
 尺寸：φ 500mm H140mm  
 輸入電壓：AC90~240V  
 光源：台製 LED  
 流明：4500lm  
 材質：鋁材 玻璃

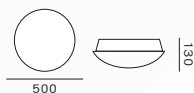

## CI-5080-4 2,500

12W×3 吸頂燈  
 尺寸：φ 400mm H130mm  
 輸入電壓：AC90~240V  
 光源：台製 LED  
 流明：3000lm  
 材質：鋁材 玻璃

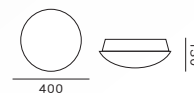





CI-5081-1

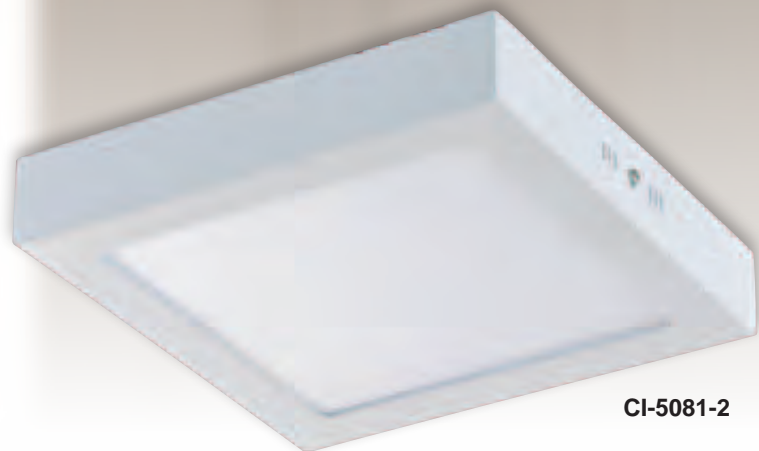

CI-5081-2



CI-5081-3

**CI-5081-1 5,900**

40Wx 吸頂燈  
 尺寸：□ 600mm H40mm  
 輸入電壓：AC90-240V  
 光源：台製 LED  
 流明：4000lm  
 材質：鋁製品 粉體烤漆

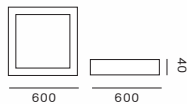

**CI-5081-2 1,130**

18Wx 吸頂燈  
 尺寸：□ 223mm H40mm  
 輸入電壓：AC90-240V  
 光源：台製 LED  
 流明：1800lm  
 材質：鋁製品 粉體烤漆

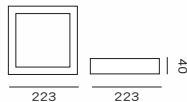

**CI-5081-3 1,430**

24Wx 吸頂燈  
 尺寸：φ 295mm H40mm  
 輸入電壓：AC90-240V  
 光源：台製 LED  
 流明：2400lm  
 材質：鋁製品 粉體烤漆



# CEILING

High efficiency high energy-saving



CI-5082-1



CI-5082-2



CI-5082-3

## CI-5082-1 5,650

40W 吸頂燈  
尺寸：φ 600mm H40mm  
輸入電壓：AC90-240V  
光源：台製 LED  
流明：4000lm  
材質：鋁製品 粉體烤漆



## CI-5082-2 4,690

30W 吸頂燈  
尺寸：φ 500mm H40mm  
輸入電壓：AC90-240V  
光源：台製 LED  
流明：3600lm  
材質：鋁製品 粉體烤漆



## CI-5082-3 3,690

30W 吸頂燈  
尺寸：φ 400mm H40mm  
輸入電壓：AC90-240V  
光源：台製 LED  
流明：3000lm  
材質：鋁製品 粉體烤漆

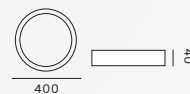

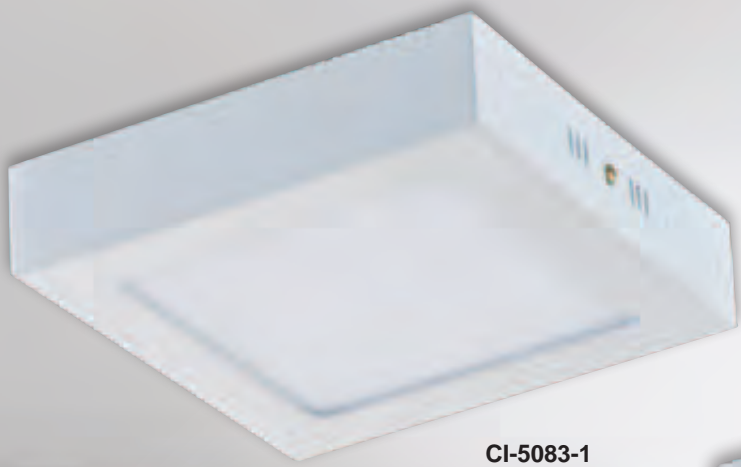

CI-5083-1

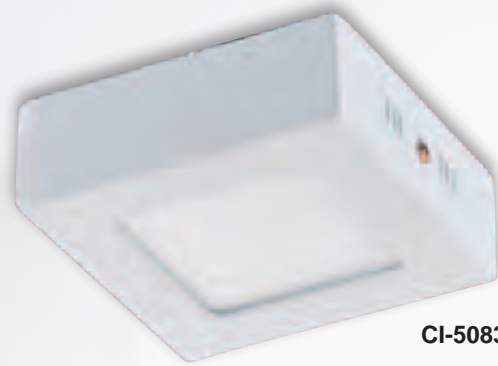

CI-5083-2

### CI-5083-1 930

12W 吸頂燈  
尺寸：□ 170mm H40mm  
輸入電壓：AC90-240V  
光源：台製 LED  
流明：1200lm  
材質：鋁製品 粉體烤漆



### CI-5083-2 580

6W 吸頂燈  
尺寸：□ 120mm H40mm  
輸入電壓：AC90-240V  
光源：台製 LED  
流明：600lm  
材質：鋁製品 粉體烤漆

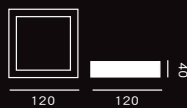

### CI-5083-3 1,080

18W 吸頂燈  
尺寸：φ 226mm H40mm  
輸入電壓：AC90-240V  
光源：台製 LED  
流明：1800lm  
材質：鋁製品 粉體烤漆



CI-5083-3

### CI-5083-4 900

12W 吸頂燈  
尺寸：φ 169mm H40mm  
輸入電壓：AC90-240V  
光源：台製 LED  
流明：1200lm  
材質：鋁製品 粉體烤漆



CI-5083-4

### CI-5083-5 580

6W 吸頂燈  
尺寸：φ 116mm H40mm  
輸入電壓：AC90-240V  
光源：台製 LED  
流明：600lm  
材質：鋁製品 粉體烤漆



CI-5083-5

# PANDENT

High efficiency high energy-saving



CI-5084-1



CI-5084-2



CI-5084-3

## CI-5084-1 6,380

E14 5W×5 吊燈  
尺寸：W390mm H450mm  
輸入電壓：AC90~240V  
光源：台製 LED  
材質：鐵材烤漆



## CI-5084-2 4,500

E14 5W×4 吊燈  
尺寸：W300mm H400mm  
輸入電壓：AC90~240V  
光源：台製 LED  
材質：鐵材烤漆



## CI-5084-3 4,500

E14 5W×3 吊燈  
尺寸：W250mm H450mm  
輸入電壓：AC90~240V  
光源：台製 LED  
材質：鐵材烤漆





CI-5085-1



CI-5085-2

**CI-5085-1 4,570**

E14 5Wx3 吊燈  
尺寸：W650mm H210mm  
輸入電壓：AC90~240V  
光源：台製 LED  
材質：鐵材烤漆

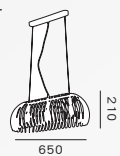

**CI-5085-2 3,750**

E14 5Wx2 吊燈  
尺寸：W540mm H210mm  
輸入電壓：AC90~240V  
光源：台製 LED  
材質：鐵材烤漆



# PANDENT

High efficiency high energy-saving



CI-5086-1



CI-5086-3



CI-5086-2

## CI-5086-1 4,500

E14 5Wx4 吊燈  
尺寸：W420mm H420mm  
輸入電壓：AC90~240V  
光源：台製 LED  
材質：鐵材烤漆



## CI-5086-2 4,130

E14 5Wx4 吊燈  
尺寸：W420mm H420mm  
輸入電壓：AC90~240V  
光源：台製 LED  
材質：鐵材烤漆



## CI-5086-3 3,750

E14 5Wx3 吊燈  
尺寸：W210mm H420mm  
輸入電壓：AC90~240V  
光源：台製 LED  
材質：鐵材烤漆

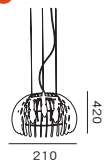



CI-5087-1

**CI-5087-1 24,750**

E14 5Wx3 水晶吊燈  
尺寸：W580mm H600mm  
輸入電壓：AC90-240V  
光源：台製 LED  
材質：鋅合金 水晶



580

# CEILING

High efficiency high energy-saving



CI-5088-1



CI-5088-2



CI-5088-3



CI-5088-4

## CI-5088-1 26,880

LED 10Wx5 半吸頂燈  
尺寸：W640mm H600mm  
輸入電壓：AC90~240V  
光源：台製 LED  
材質：銅鍍金 姆拉諾玻璃

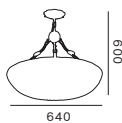

## CI-5088-2 26,880

LED 10Wx5 半吸頂燈  
尺寸：W600mm H600mm  
輸入電壓：AC90~240V  
光源：台製 LED  
材質：銅鍍金 姆拉諾玻璃

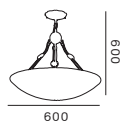

## CI-5088-3 16,130

LED 10Wx3 半吸頂燈  
尺寸：W520mm H400mm  
輸入電壓：AC90~240V  
光源：台製 LED  
材質：銅鍍金 姆拉諾玻璃

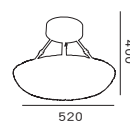

## CI-5088-4 16,130

LED 10Wx3 半吸頂燈  
尺寸：W500mm H400mm  
輸入電壓：AC90~240V  
光源：台製 LED  
材質：銅鍍金 姆拉諾玻璃

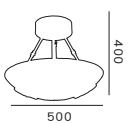





CI-5089-1



CI-5089-2



CI-5089-3



CI-5089-4

**CI-5089-1 16,130**

LED 10Wx3 半吸頂燈  
尺寸：W520mm H400mm  
輸入電壓：AC90-240V  
光源：台製 LED  
材質：銅鍍金 姆拉諾玻璃

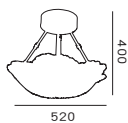

**CI-5089-2 16,130**

LED 10Wx3 半吸頂燈  
尺寸：W500mm H400mm  
輸入電壓：AC90-240V  
光源：台製 LED  
材質：銅鍍金 姆拉諾玻璃

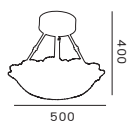

**CI-5089-3 16,130**

LED 10Wx3 半吸頂燈  
尺寸：W520mm H400mm  
輸入電壓：AC90-240V  
光源：台製 LED  
材質：銅鍍金 姆拉諾玻璃

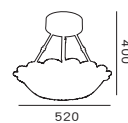

**CI-5089-4 16,130**

LED 10Wx3 半吸頂燈  
尺寸：W520mm H400mm  
輸入電壓：AC90-240V  
光源：台製 LED  
材質：銅鍍金 姆拉諾玻璃

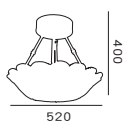

# CEILING

High efficiency high energy-saving



CI-5090-1

## CI-5090-1 訂製品

尺寸：φ 150mm H200mm  
光源：LED 30W  
流明：2500lm  
材質：鋁材

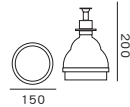

## CI-5090-2 訂製品

尺寸：φ 215mm H300mm  
光源：LED 60W  
流明：5000lm  
材質：鋁材

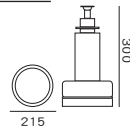

## CI-5090-3 訂製品

尺寸：φ 215mm H340mm  
光源：LED 100W  
流明：8000lm  
材質：鋁材

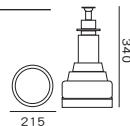

CI-5090-2



CI-5090-3



E27 燈頭



E40 燈頭



CI-5091-2



CI-5091-3



CI-5091-1

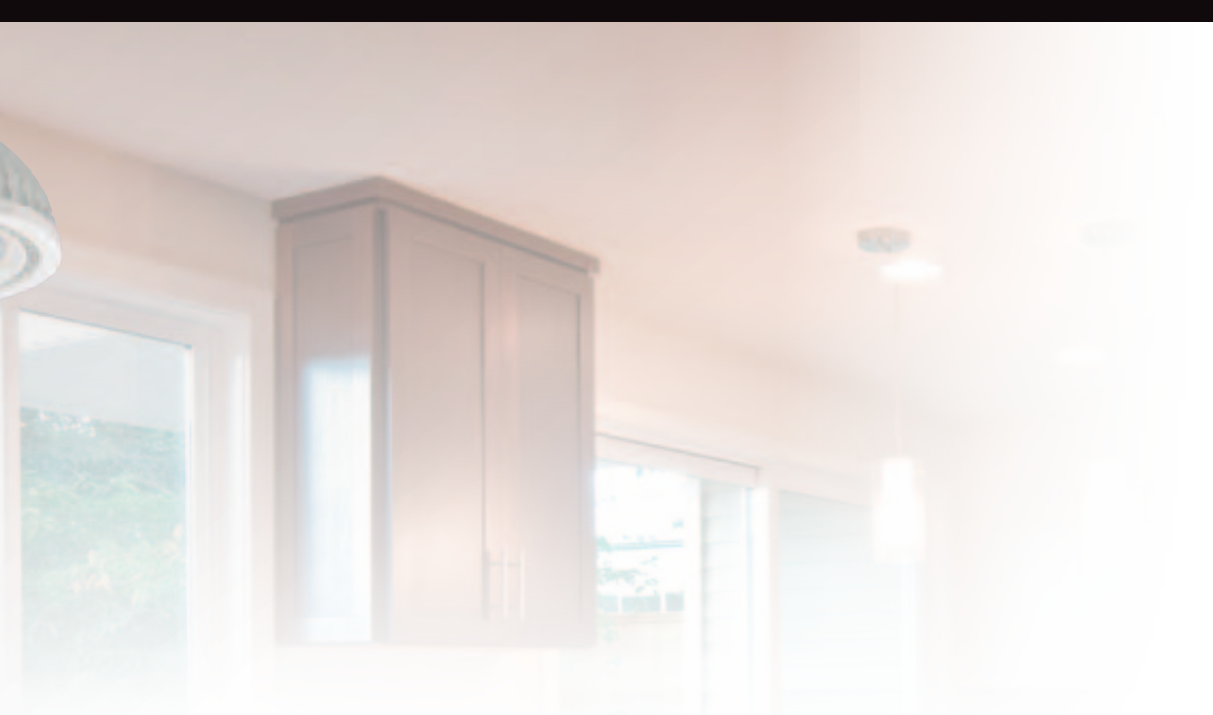

**CI-5091-1 1,200**

尺寸：φ 95mm H105mm  
 光源：E27 LED10W  
 材質：鋁材

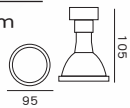

**CI-5091-2 450**

尺寸：φ 65mm H120mm  
 光源：E27 LED10W  
 材質：鋁材

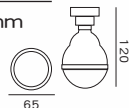

**CI-5091-3 450**

尺寸：φ 65mm H120mm  
 光源：E27 LED10W  
 材質：鋁材

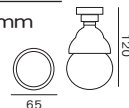

# PANDENT

High efficiency high energy-saving



CI-5092-1



CI-5092-2



CI-5092-3



CI-5092-4

## CI-5092-1 1,130

尺寸：φ 355mm H290mm  
光源：E27（光源另計）  
流明：0000lm  
材質：鐵材 鍍鉻 PC 罩

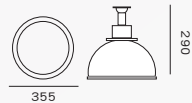

## CI-5092-2 1,130

尺寸：φ 355mm H290mm  
光源：E27（光源另計）  
流明：0000lm  
材質：鐵材 鍍鉻 PC 罩

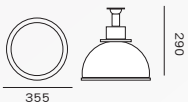

## CI-5092-3 690

尺寸：φ 410mm H360mm  
光源：E27（光源另計）  
流明：0000lm  
材質：鋁旋壓陽極處理

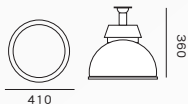

## CI-5092-4 1,130

尺寸：φ 310mm H340mm  
光源：E27（光源另計）  
流明：0000lm  
材質：鐵材 鍍鉻 PC 罩

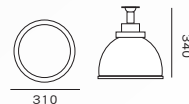



CI-5093-1

**CI-5093-1 1,750**

尺寸：φ 360mm H390mm  
 光源：E27 (光源另計)  
 流明：0000lm  
 材質：鐵材 鍍鉻 PC 罩



CI-5093-2

**CI-5093-2 1,380**

尺寸：φ 310mm H215mm  
 光源：E27 (光源另計)  
 流明：0000lm  
 材質：鐵材 鍍鉻 PC 罩

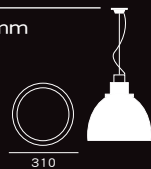

CI-5093-3

**CI-5093-3 1,750**

尺寸：φ 360mm H300mm  
 光源：E27 (光源另計)  
 流明：0000lm  
 材質：鐵材 鍍鉻 PC 罩

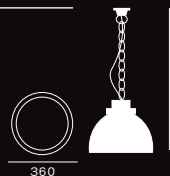

CI-5093-4

**CI-5093-4 1,880**

尺寸：φ 360mm H300mm  
 光源：E27 (光源另計)  
 流明：0000lm  
 材質：

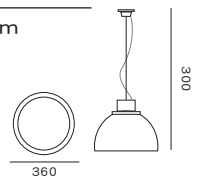

# PANDENT

High efficiency high energy-saving



CI-5094-1



CI-5094-2



CI-5094-3

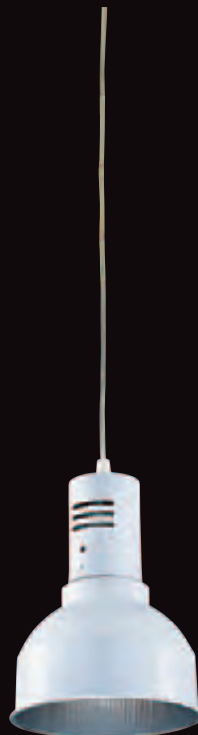

CI-5094-4

## CI-5094-1 2,380

尺寸：φ 320mm H450mm  
光源：E27（光源另計）  
流明：0000lm  
材質：

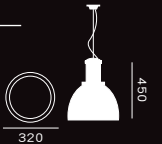

## CI-5094-2 1,750

尺寸：φ 310mm H310mm  
光源：E27（光源另計）  
流明：0000lm  
材質：鋁罩 電鍍烤漆

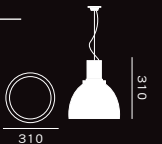

## CI-5094-3 1,880

尺寸：φ 310mm H380mm  
光源：E27（光源另計）  
流明：0000lm  
材質：PC罩 電鍍烤漆



## CI-5094-4 880

尺寸：φ 155mm H220mm  
光源：E27（光源另計）  
流明：0000lm  
材質：鋁材 粉體烤漆

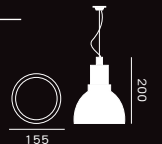

When considering ceiling lighting, Recessed Lighting has become a very popular option. Used frequently in home remodels and in new home construction recessed lighting works great in almost any location in the home. Versatile and available in a multitude of sizes and lamp combinations recessed ceiling lighting is an affordable and attractive solution for whatever your application. Before buying be sure to read our blog to learn more about designing with recessed lighting and you will also want to read our article Recessed Lighting Tips and General Guidelines.

## FLUORESCENT

Recessed Lighting has become a very popular option

088

## SPOT LIGHT

Used frequently in home remodels

095

## OUTDOOR

Versatile and available in a multitude of sizes and lamp

102

## WALL

recessed ceiling lighting is an affordable and attractive solution

104

## SENSOR LIGHT

Lighting Tips and General Guidelines

105

## OUTDOOR SPOT

attractive solution for whatever application

112

## LED SERIES

Lighting has become a very popular option

116

## LAMPS

more about designing with recessed

123

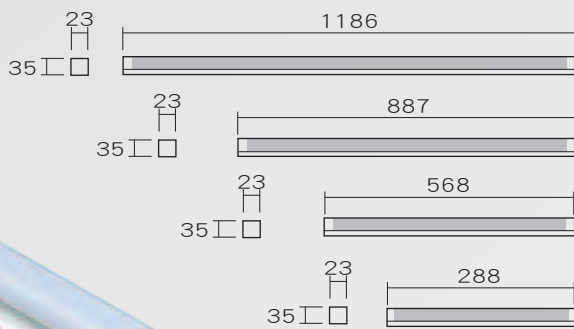

CI-5096-3

CI-5096-1

- CI-5096-1 750
- CI-5096-2 725
- CI-5096-3 500
- CI-5096-4 475

- 規格 :T5 連結燈
- 消耗功率 :20W & 15W & 10W & 5W
- LED: 台光牌 LED Inside
- 輸入電壓 :AC 90-240V
- 輸出流明 :2000lm & 1500lm & 1000lm & 500lm
- 顏色 :W/WW
- 演色性 CRI:84
- 出光角度 :260
- 工作壽命 :30,000 小時
- 材質 : 塑料
- 尺寸 (mm): 573\*25\*33 & 860\*25\*33 & 1122\*25\*33

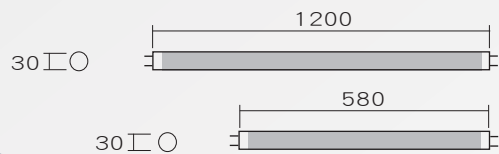

CI-5096-5

CI-5096-6

- CI-5096-5 750
- CI-5096-6 500

- 規格 :T8 燈管
- 消耗功率 :10W & 20W
- LED: 台光牌 LED Inside
- 輸入電壓 :AC 90-240V
- 輸出流明 :1000lm & 2000lm
- 顏色 :W/WW
- 演色性 CRI:84
- 出光角度 :260
- 工作壽命 :30,000 小時
- 材質 : 散熱塑料
- 尺寸 (mm):580\*30 & 1200\*30





CI-5097-1

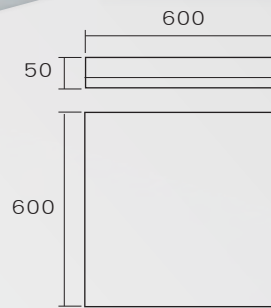

- CI-5097-1 3,750
- SL-781 平板燈
- 規格: 平板 × 4PCS
- 消耗功率: 40W
- LED: 台光牌 LED Inside
- 輸入電壓: AC 90-240V
- 輸出流明: 4000lm
- 顏色: W/WW
- 演色性 CRI: 76
- 出光角度: 160
- 工作壽命: 30,000 小時
- 材質: 鋁 & 鋼
- 尺寸 (mm): 600\*600\*50

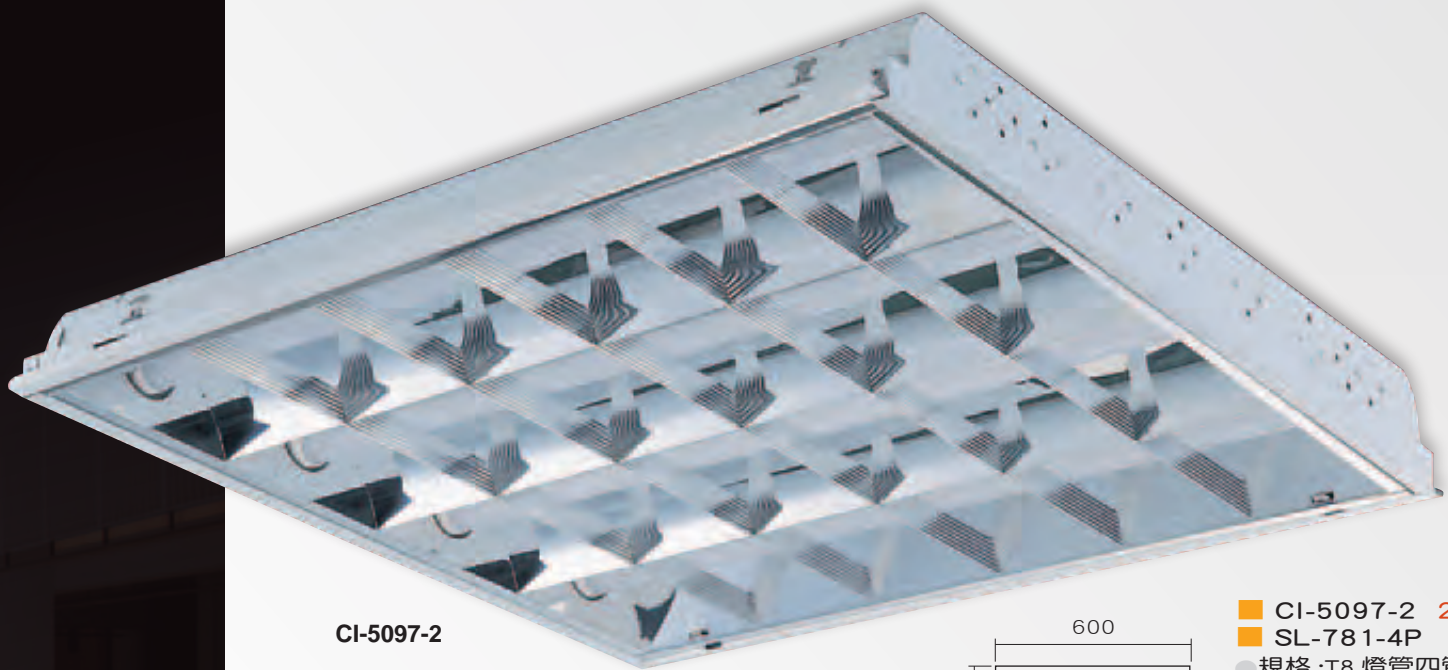

CI-5097-2

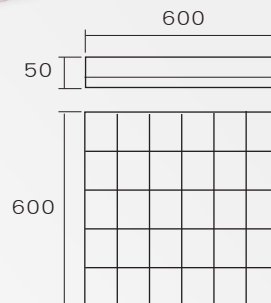

- CI-5097-2 2,715
- SL-781-4P
- 規格: T8 燈管四管
- 消耗功率: 10W & 20W
- LED: 台光牌 LED Inside
- 輸入電壓: AC 90-240V
- 輸出流明: 4000lm
- 顏色: W/WW
- 演色性 CRI: 76
- 出光角度: 160
- 工作壽命: 30,000 小時
- 材質: 鋁 & 鋼
- 尺寸 (mm): 600\*600\*50

# FLOURESCENT

High efficiency high energy-saving

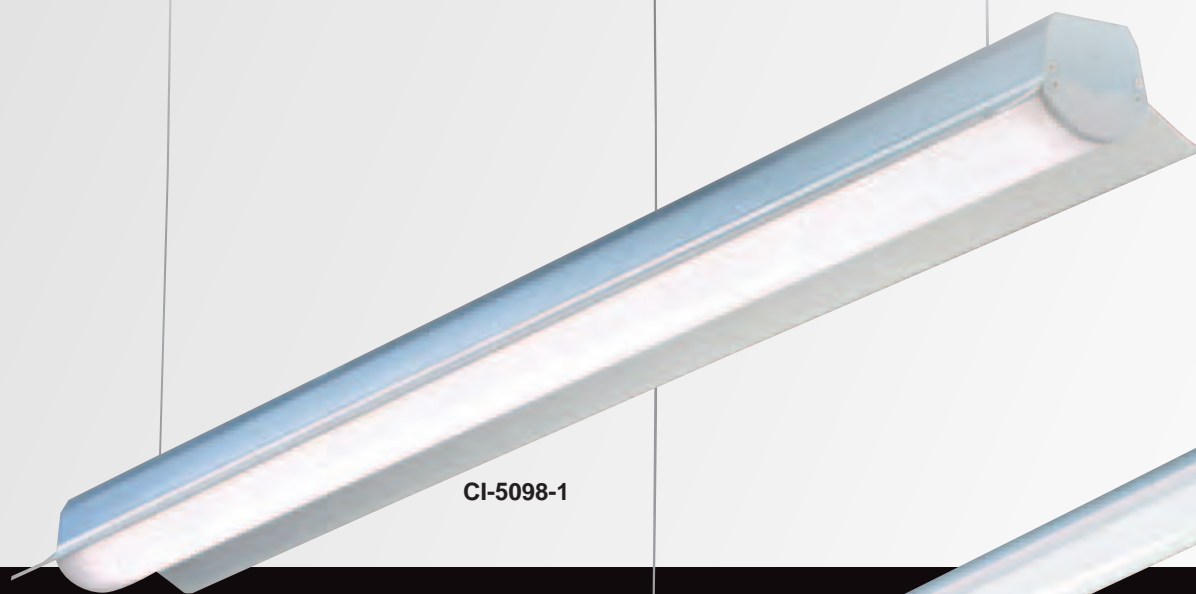

CI-5098-1



CI-5098-2

## CI-5098-1 5,250

尺寸：L1160mm W150mm H80mm  
 光源：LED 模組 40W  
 流明：3600lm  
 材質：鋁擠壓成型 PC 罩

## CI-5098-2 5,250

尺寸：L1420mm W100mm H70mm  
 光源：LED 模組 40W  
 流明：3600lm  
 材質：鋁擠壓成型 PC 罩

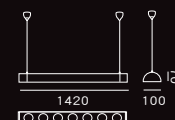
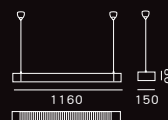

CI-5098-3

## CI-5098-3 4,500

尺寸：L1160mm W86mm H30mm  
 光源：LED 模組 20Wx1  
 流明：1800lm  
 材質：陽極處理 壓克力燈罩

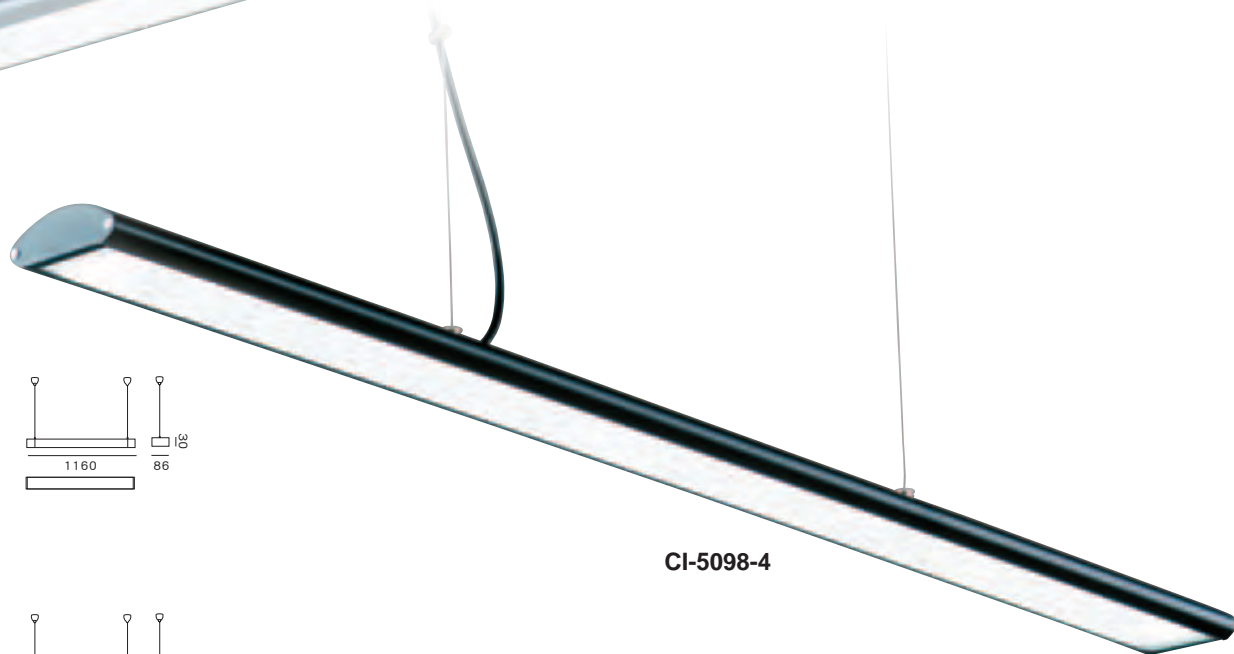
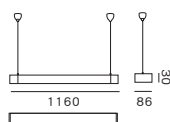

CI-5098-4

## CI-5098-4 4,500

尺寸：L1160mm W86mm H30mm  
 光源：LED 模組 20Wx1  
 流明：1800lm  
 材質：粉體烤漆 壓克力燈罩

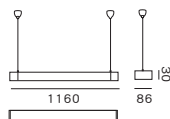

### CI-5099-1 5,750

尺寸：L1230mm W68mm H60mm  
 光源：T8-LED 燈管 20W×1  
 流明：1800lm  
 材質：粉體烤漆 防眩光格柵

### CI-5099-2 5,100

尺寸：L1230mm W68mm H60mm  
 光源：T8-LED 燈管 20W×1  
 流明：1800lm  
 材質：粉體烤漆 壓克力燈罩

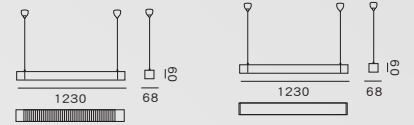

CI-5099-1



CI-5099-2

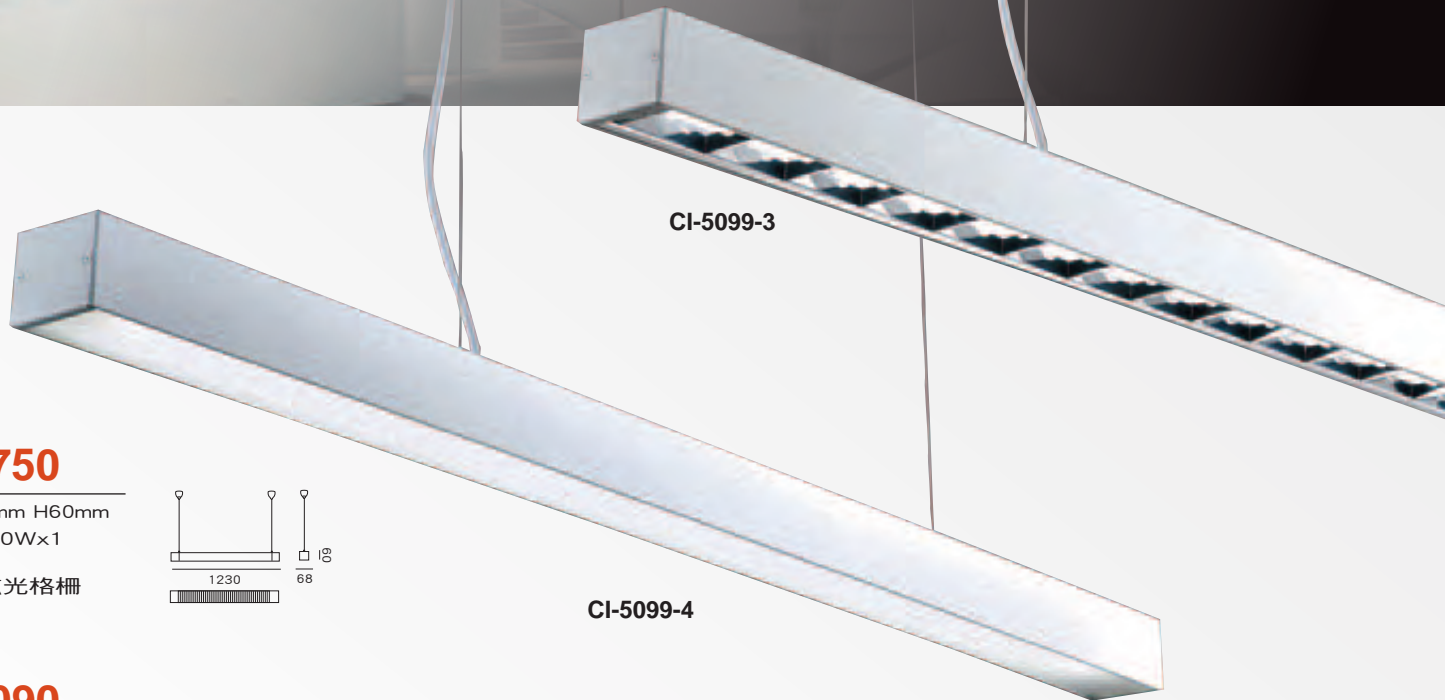

CI-5099-3

### CI-5099-3 5,750

尺寸：L1230mm W68mm H60mm  
 光源：T8-LED 燈管 20W×1  
 流明：1800lm  
 材質：陽極處理 防眩光格柵

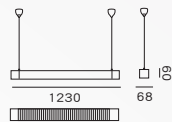

### CI-5099-4 5,090

尺寸：L1230mm W105mm H55mm  
 光源：T8-LED 燈管 20W×1  
 流明：1800lm  
 材質：陽極處理 壓克力燈罩

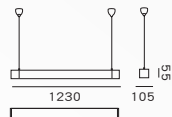

CI-5099-4

# FLOURESCENT

High efficiency high energy-saving



CI-5100-1



CI-5100-2

## CI-5100-1 5,500

尺寸：L1200mm W60mm H80mm  
光源：LED 模組 40W  
流明：3000lm  
材質：陽極處理 壓克力燈罩

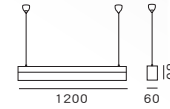

## CI-5100-2 5,500

尺寸：L1080mm W40mm H70mm  
光源：LED 模組 40W  
流明：3600lm  
材質：陽極處理 防眩光格柵

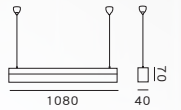

## CI-5100-3 4,500

尺寸：L1200mm W40mm H60mm  
光源：LED 模組 40W  
流明：3600lm  
材質：粉體烤漆 壓克力燈罩

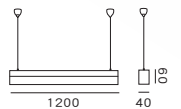

CI-5100-3

## CI-5100-4 3,380

尺寸：L1000mm W20mm H40mm  
光源：LED 模組 20W  
流明：1800lm  
材質：粉體烤漆 防眩光格柵

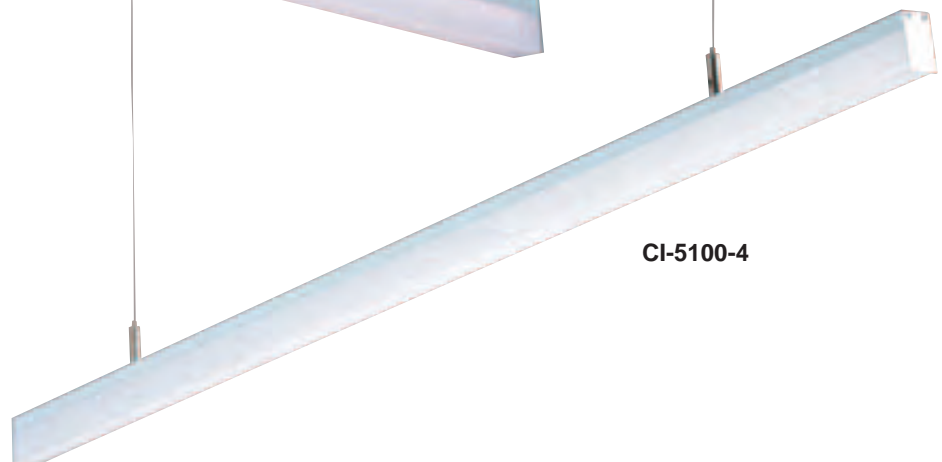
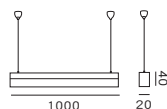

CI-5100-4

## CI-5101-1 8,250

尺寸：L1200mm W120mm H70mm  
 光源：LED 模組 50W  
 流明：5000lm  
 材質：鋁擠壓成型 PC 罩

CI-5101-1

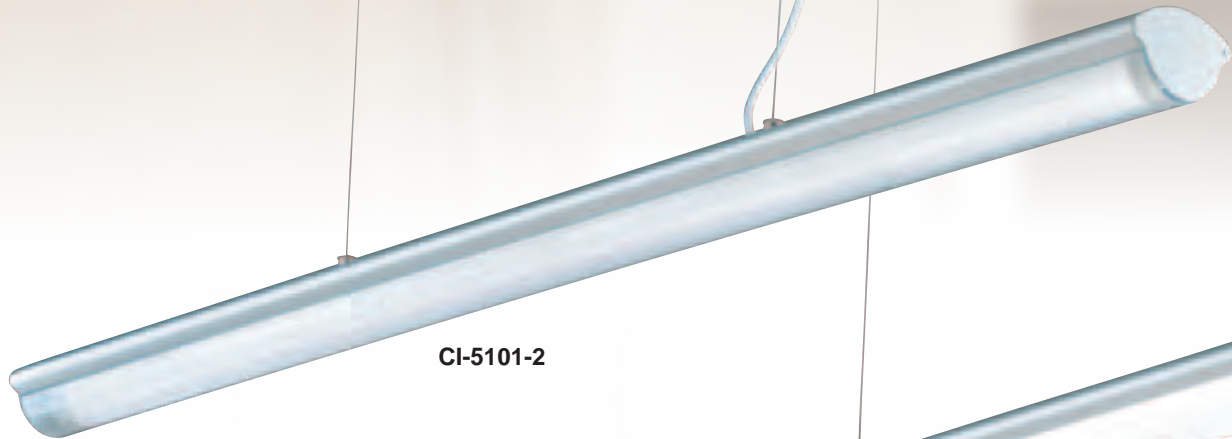
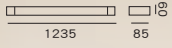

CI-5101-2

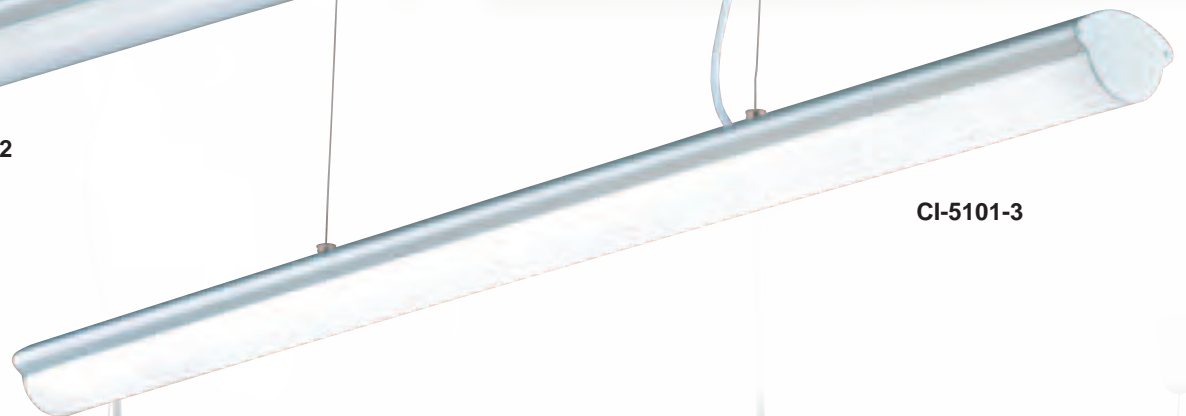

CI-5101-3

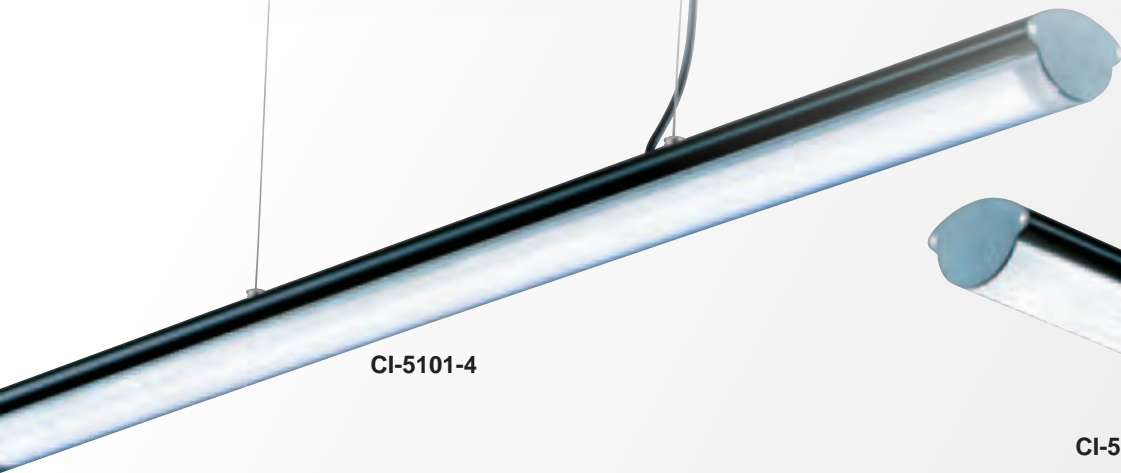

CI-5101-4



CI-5101-5

## CI-5101-2 4,200

尺寸：L1235mm W86mm H60mm  
 光源：T8-LED 燈管 20Wx1  
 流明：1800lm  
 材質：粉體烤漆

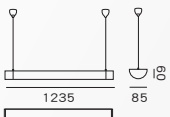

## CI-5101-3 4,200

尺寸：L1235mm W86mm H60mm  
 光源：T8-LED 燈管 20Wx1  
 流明：1800lm  
 材質：粉體烤漆

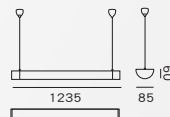

## CI-5101-4 4,200

尺寸：L1235mm W86mm H60mm  
 光源：T8-LED 燈管 20Wx1  
 流明：1800lm  
 材質：粉體烤漆 PC 燈罩

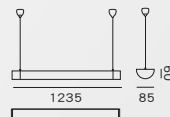

## CI-5101-5 4,500

尺寸：L1235mm W86mm H60mm  
 光源：T8-LED 燈管 20Wx1  
 流明：1800lm  
 材質：粉體烤漆 PC 燈罩

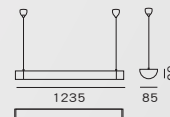

# FLOURESCENT

High efficiency high energy-saving

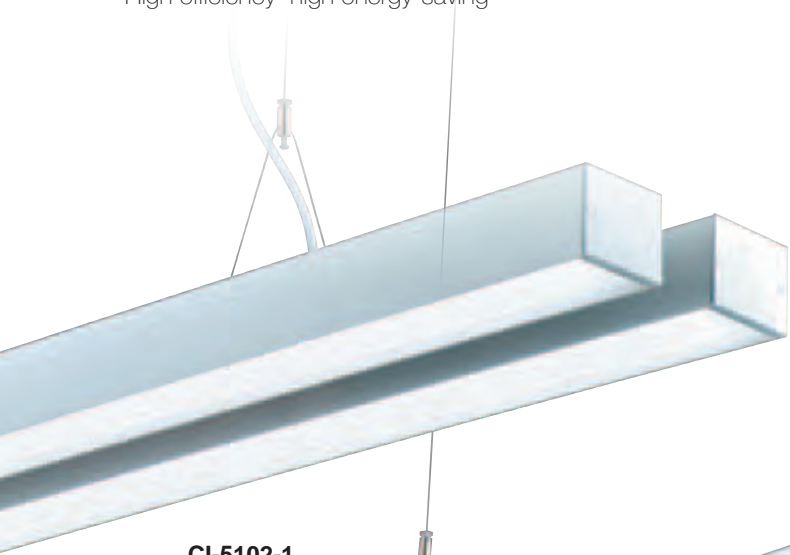

CI-5102-1

## CI-5102-1 7,230

尺寸：L1230mm W178mm H60mm  
 光源：T8-LED 燈管 20W×2  
 流明：3600lm  
 材質：陽極處理 壓克力燈罩

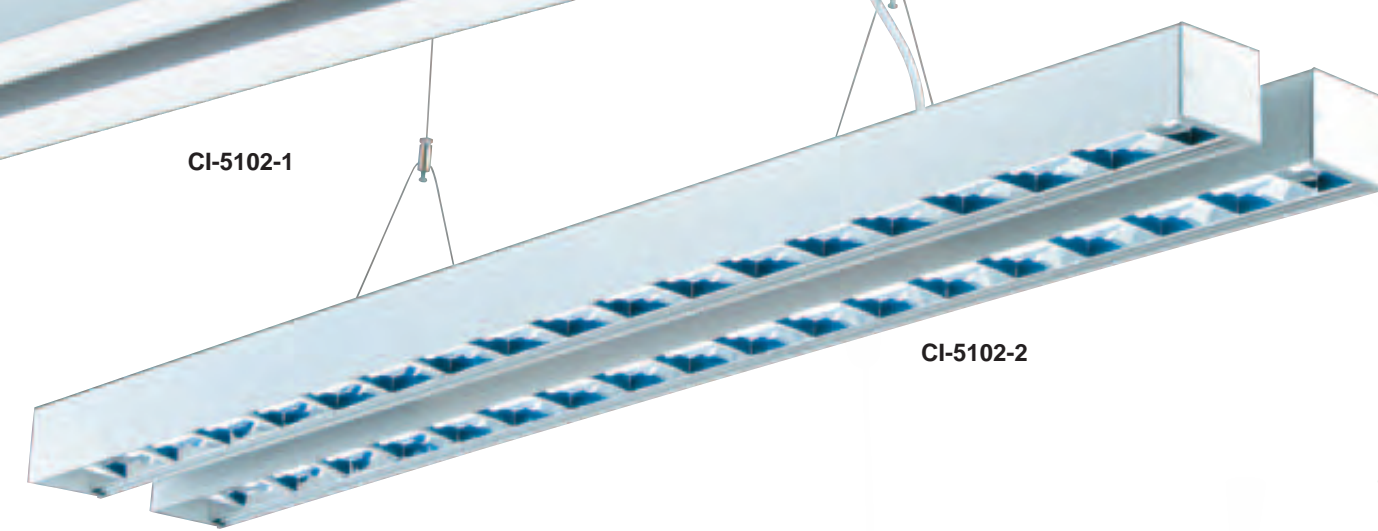
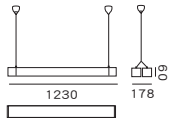

CI-5102-2

## CI-5102-2 7,990

尺寸：L1230mm W178mm H60mm  
 光源：T8-LED 燈管 20W×2  
 流明：3600lm  
 材質：陽極處理 防眩光格柵

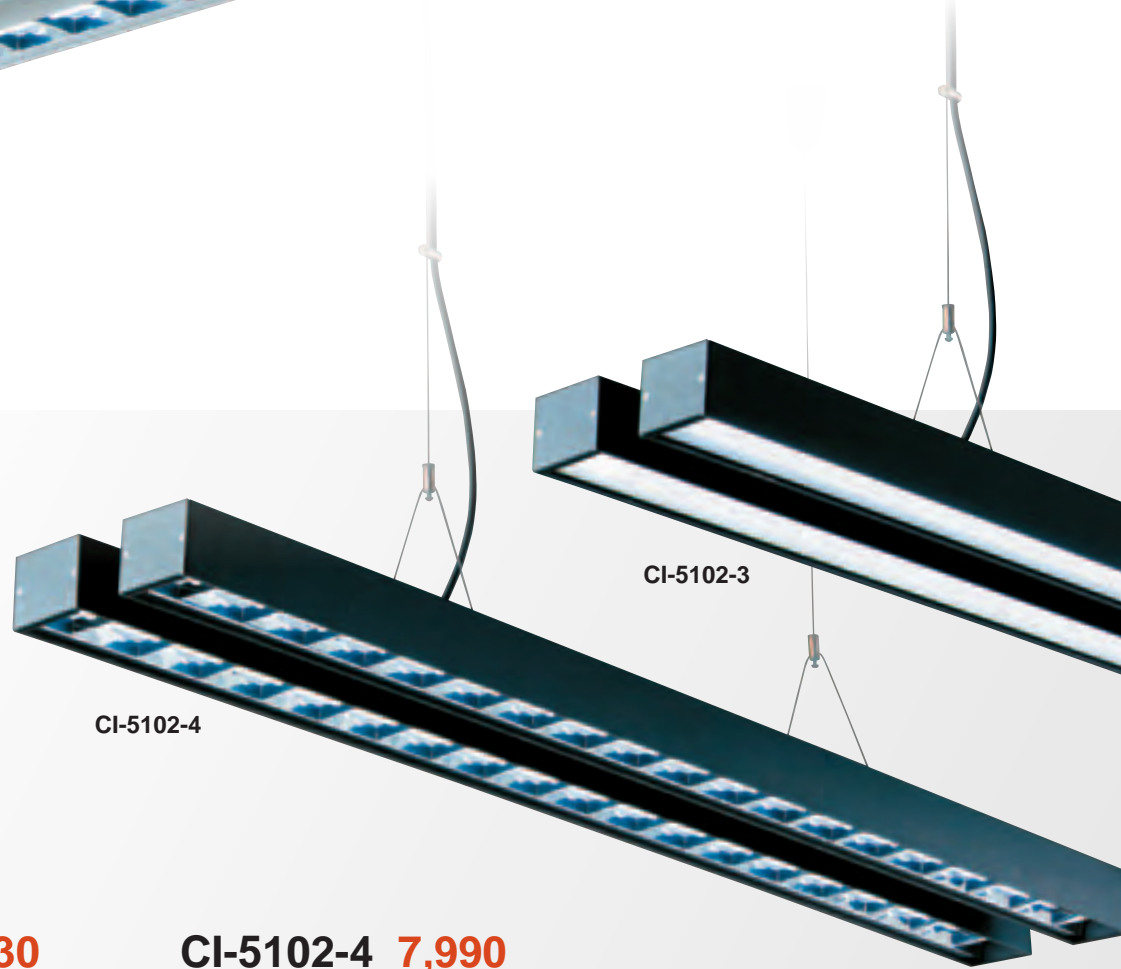
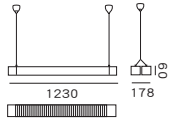

CI-5102-3

CI-5102-4

## CI-5102-3 7,230

尺寸：L1230mm W178mm H60mm  
 光源：T8-LED 燈管 20W×2  
 流明：3600lm  
 材質：粉體烤漆 壓克力燈罩

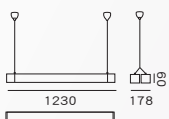

## CI-5102-4 7,990

尺寸：L1230mm W178mm H60mm  
 光源：T8-LED 燈管 20W×2  
 流明：3600lm  
 材質：粉體烤漆 防眩光格柵

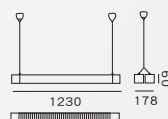

outdoor SPOT  
High efficiency high energy-saving



CI-5103-1



CI-5103-2

## 充電式照明燈

### CI-5103-1 2,100

尺寸：L1230mm W178mm H60mm  
光源：LED 10W  
流明：1000lm  
材質：陽極處理 壓克力燈罩

### CI-5103-2 2,100

尺寸：L1230mm W178mm H60mm  
光源：LED 10W  
流明：1000lm  
材質：陽極處理 防眩光格柵



outdoor SPOT  
High efficiency high energy-saving



CI-5104-1

**CI-5104-1 11,000**

尺寸：D140mm W390mm H270mm  
光源：LED 30W×2 CREE LED  
流明：6000lm  
材質：鋁壓鑄 PC 罩



CI-5104-3



CI-5104-2

**CI-5104-2 11,000**

尺寸：D315mm W315mm H130mm  
光源：LED 30W×2 CREE LED  
流明：6000lm  
材質：鋁壓鑄 PC 罩

**CI-5104-3 8,900**

尺寸：D225mm W225mm H140mm  
光源：LED 30W CREE LED  
流明：3000lm  
材質：鋁壓鑄 PC 罩



CI-5104-4



CI-5104-5

**CI-5104-4 8,900**

尺寸：Φ300mm H130mm  
光源：LED 30W CREE LED  
流明：3000lm  
材質：鋁壓鑄 PC 罩

**CI-5104-5 11,000**

尺寸：Φ400mm H140mm  
光源：LED 30W×2 CREE LED  
流明：6000lm  
材質：鋁壓鑄 PC 罩



### CI-5105-1 6,800

尺寸：D290mm W270mm H300mm  
光源：LED 30W CREE LED  
流明：3000lm  
材質：鋁壓鑄 PC 罩



CI-5105-1

### CI-5105-2 6,800

尺寸：D200mm W270mm H270mm  
光源：LED 30W CREE LED  
流明：3000lm  
材質：鋁壓鑄 PC 罩



CI-5105-2

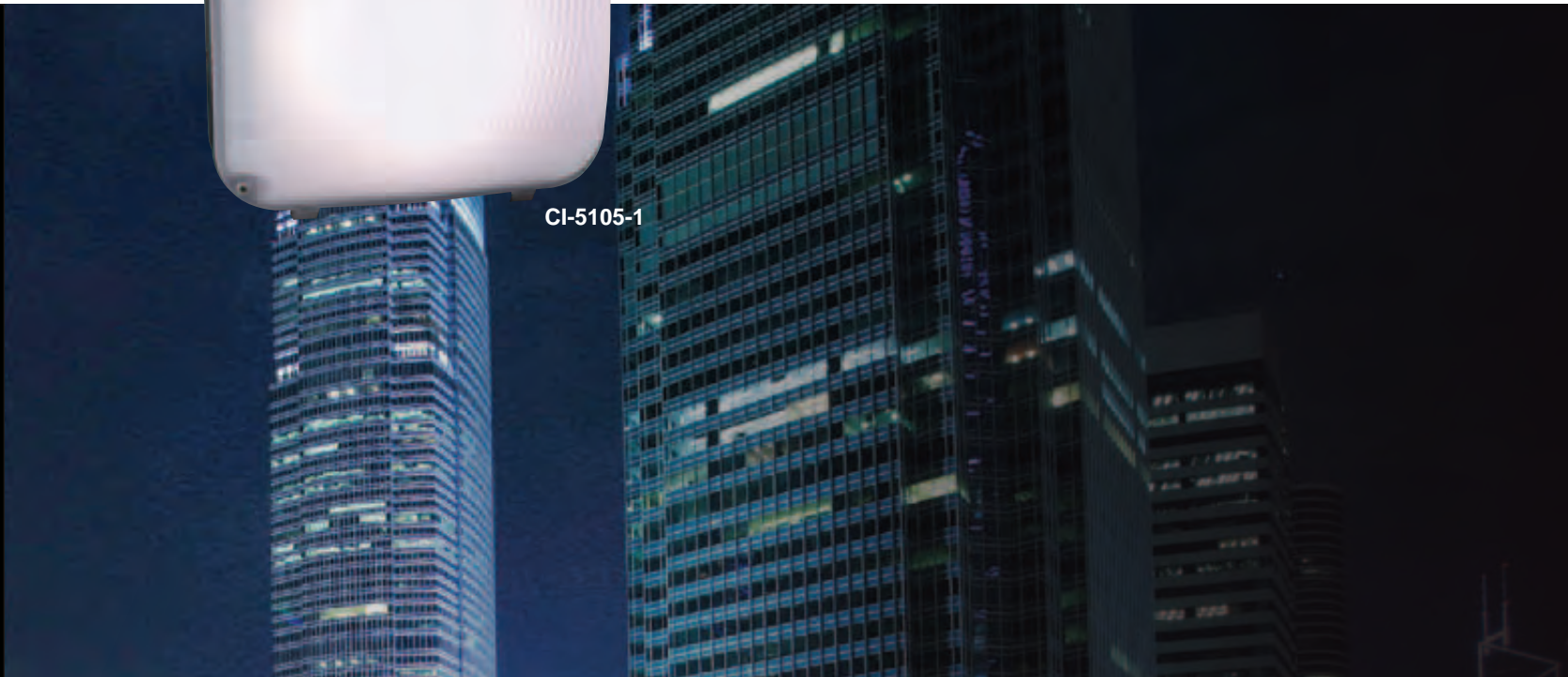

CI-5105-3

### CI-5105-3 6,200

尺寸：W260mm H130mm  
光源：LED 8W 台光牌 LED  
流明：600lm  
材質：鋁壓鑄 PC 罩

outdoor SPOT  
High efficiency high energy-saving



CI-5106-1

**CI-5106-1 6,980**

尺寸：L320mm W350mm H105mm  
光源：LED 60W **CREE** LED  
流明：5000lm  
材質：鋁壓鑄 粉體烤漆 玻璃



CI-5106-2

**CI-5106-2 4,980**

尺寸：L220mm W280mm H80mm  
光源：LED 30W **CREE** LED  
流明：3000lm  
材質：鋁壓鑄 粉體烤漆 玻璃



CI-5106-3

**CI-5106-3 2,380**

尺寸：L75mm W145mm H50mm  
光源：LED 10W **CREE** LED  
流明：1000lm  
材質：鋁壓鑄 粉體烤漆 玻璃





CI-5107-1



CI-5107-2



CI-5107-3



CI-5107-4

**CI-5107-1 9,990**

尺寸：L425mm W325mm H200mm  
 光源：LED 30Wx2 **CREE** LED  
 流明：5000lm  
 材質：鋁壓鑄 粉體烤漆 玻璃

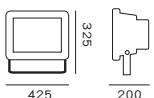

**CI-5107-2 11,700**

尺寸：L425mm W325mm H200mm  
 光源：LED 30Wx3 **CREE** LED  
 流明：9000lm  
 材質：鋁壓鑄 粉體烤漆 玻璃

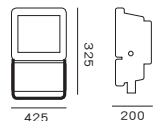

**CI-5107-3 7,750**

尺寸：L290mm W360mm H100mm  
 光源：LED 30Wx2 **CREE** LED  
 流明：5000lm  
 材質：鋁壓鑄 粉體烤漆 玻璃

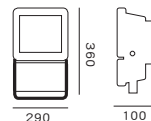

**CI-5107-4 6,230**

尺寸：L286mm W347mm H115mm  
 光源：LED 60Wx1 **CREE** LED  
 流明：5000lm  
 材質：鋁壓鑄 粉體烤漆 玻璃

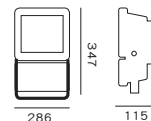

outdoor SPOT  
High efficiency high energy-saving



CI-5108-1



CI-5108-2

### CI-5108-1 3,590

30W 戶外燈  
尺寸：L230mm W180mm H130mm  
輸入電壓：AC90-240V  
光源：CREE inside  
流明：2800lm  
材質：鋁壓鑄 粉體烤漆 玻璃

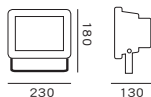

### CI-5108-2 2,100

20W 戶外燈  
尺寸：L180mm W140mm H100mm  
輸入電壓：AC90-240V  
光源：CREE inside  
流明：1800lm  
材質：鋁壓鑄 粉體烤漆 玻璃

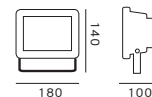



CI-5109-2



CI-5109-1



CI-5109-3



CI-5109-4

### CI-5109-1 3,850

COB 20W 戶外燈  
尺寸：D50mm H210mm W180mm  
輸入電壓：AC90~240V  
光源：CREE inside  
流明：1600lm  
材質：鋁材 粉體烤漆

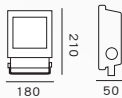

### CI-5109-2 3,820

COB 10W 戶外燈  
尺寸：D40mm H200mm W150mm  
輸入電壓：AC90~240V  
光源：CREE inside  
流明：1000lm  
材質：鋁材 粉體烤漆

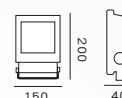

### CI-5109-3 3,190

COB 20W 戶外燈  
尺寸：D100mm H150mm W180mm  
輸入電壓：AC90~240V  
光源：CREE inside  
流明：1600lm  
材質：鋁材 粉體烤漆

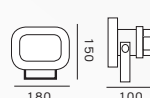

### CI-5109-4 2,080

COB 5W 戶外燈  
尺寸：D90mm H110mm W140mm  
輸入電壓：AC90~240V  
光源：CREE inside  
流明：500lm  
材質：鋁材 粉體烤漆

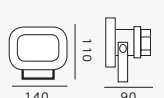

outdoor SPOT  
High efficiency high energy-saving



CI-5110-1



CI-5110-2



CI-5110-3

**CI-5110-1 4,290**

COB 20W 感應式戶外燈  
尺寸：W180mm H250mm  
輸入電壓：AC90-240V  
光源：CREE inside  
流明：1600lm  
材質：壓鑄鋁 粉體烤漆

**CI-5110-2 4,290**

COB 20W 感應式戶外燈  
尺寸：W180mm H230mm  
輸入電壓：AC90-240V  
光源：台製 LED  
流明：1600lm  
材質：壓鑄鋁 粉體烤漆

**CI-5110-3 4,890**

COB 20W 感應式戶外燈  
尺寸：W180mm H230mm  
輸入電壓：AC90-240V  
光源：CREE inside  
流明：1600lm  
材質：壓鑄鋁 粉體烤漆



**CI-5110-4 3,790**

20W 戶外燈  
尺寸：D115mm H150mm W180mm  
輸入電壓：AC90-240V  
光源：台製 LED  
流明：1700lm  
材質：鋁材 粉體烤漆

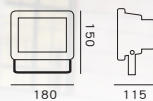

CI-5110-4



CI-5111-1



CI-5111-2



CI-5111-3

### CI-5111-1 2,590

10W 戶外燈  
 尺寸：D86mm H440mm W240mm  
 輸入電壓：AC90-240V  
 光源：台製 LED  
 流明：900lm  
 材質：鋁材 粉體烤漆

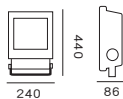

### CI-5111-2 2,170

5W 戶外燈  
 尺寸：Φ100mm H130mm  
 輸入電壓：AC90-240V  
 光源：台製 LED  
 流明：400lm  
 材質：鋁材 粉體烤漆

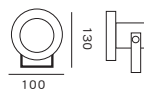

### CI-5111-3 2,040

8W 戶外燈  
 尺寸：D90mm H130mm W115mm  
 輸入電壓：AC90-240V  
 光源：台製 LED  
 流明：700lm  
 材質：鋁材 粉體烤漆

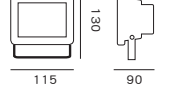

outdoor SPOT  
High efficiency high energy-saving



CI-5112-1



CI-5112-2



CI-5112-3



CI-5112-4

**CI-5112-1 4,740**

尺寸：φ 160mm H350mm  
光源：LED 15W  
流明：1300lm  
材質：鋁壓鑄 粉體烤漆  
玻璃燈罩

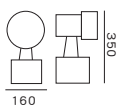

**CI-5112-2 4,180**

尺寸：φ 160mm H450mm  
光源：LED 15W  
流明：1300lm  
材質：鋁壓鑄 粉體烤漆  
玻璃燈罩

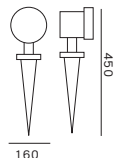

**CI-5112-3 2,000**

尺寸：φ 100mm H175mm  
光源：LED 5W×1  
流明：400lm  
材質：鋁壓鑄 粉體烤漆  
玻璃燈罩

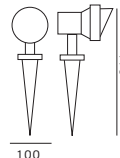

**CI-5112-4 2,000**

尺寸：φ 100mm H175mm  
光源：LED 5W×1  
流明：400lm  
材質：鋁壓鑄 粉體烤漆  
玻璃燈罩

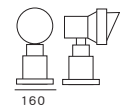





CI-5113-1



CI-5113-2



CI-5113-3



CI-5113-4



CI-5113-5

### CI-5113-1 4,180

尺寸：φ 160mm H450mm  
 光源：LED 15W×1  
 流明：1300lm  
 材質：鋁壓鑄 粉體烤漆  
 玻璃燈罩

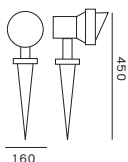

### CI-5113-2 4,740

尺寸：φ 160mm H350mm  
 光源：LED 15W×1  
 流明：1300lm  
 材質：鋁壓鑄 粉體烤漆  
 玻璃燈罩

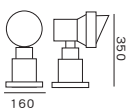

### CI-5113-3 2,380

尺寸：φ 100mm H320mm  
 光源：LED 5W×1  
 流明：400lm  
 材質：鋁壓鑄 粉體烤漆  
 玻璃燈罩

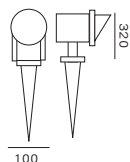

### CI-5113-4 2,380

尺寸：φ 100mm H320mm  
 光源：LED 5W×1  
 流明：400lm  
 材質：鋁壓鑄 粉體烤漆  
 玻璃燈罩

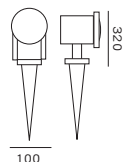

### CI-5113-5 2,380

尺寸：φ 100mm H320mm  
 光源：LED 5W×1  
 流明：400lm  
 材質：鋁壓鑄 粉體烤漆  
 玻璃燈罩

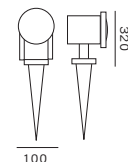

# outdoor BRACKET

High efficiency high energy-saving



CI-5114-1



CI-5114-2



CI-5114-3



CI-5114-4



CI-5114-5



CI-5114-6



CI-5114-7

## CI-5114-1 2,630

尺寸：W185mm H280mm D91mm  
光源：LED 12W×1  
流明：1000lm  
材質：本體鋁壓鑄成型 粉體烤漆  
PC 燈罩



## CI-5114-2 2,630

尺寸：W185mm H280mm D91mm  
光源：LED 12W×1  
流明：1000lm  
材質：本體鋁壓鑄成型 粉體烤漆  
PC 燈罩



## CI-5114-3 2,630

尺寸：W185mm H280mm D91mm  
光源：LED 12W×1  
流明：1000lm  
材質：本體鋁壓鑄成型 粉體烤漆  
PC 燈罩

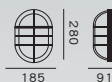

## CI-5114-4 3,410

尺寸：L200mm H350mm D125mm  
光源：LED 12W×1  
流明：1000lm  
材質：本體鋁壓鑄成型  
粉體烤漆 玻璃燈罩



## CI-5114-5 3,410

尺寸：L200mm H350mm D125mm  
光源：LED 12W×1  
流明：1000lm  
材質：本體鋁壓鑄成型  
粉體烤漆 玻璃燈罩



## CI-5114-6 2,720

尺寸：L120mm H350mm D110mm  
光源：LED 12W×1  
流明：1000lm  
材質：鋁壓鑄成型 PC 燈罩



## CI-5114-7 3,570

尺寸：L180mm H306mm D125mm  
光源：LED 12W×1  
流明：1000lm  
材質：鋁壓鑄成型 PC 燈罩





CI-5115-1



CI-5115-2

**CI-5115-1 2,220**

尺寸：L290mm H120mm D135mm  
 光源：LED 12Wx1  
 流明：1000lm  
 材質：鋁壓鑄成型 PC 燈罩

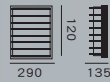

**CI-5115-2 2,630**

尺寸：L290mm H120mm D130mm  
 光源：LED 12Wx1  
 流明：1000lm  
 材質：鋁壓鑄成型 PC 燈罩

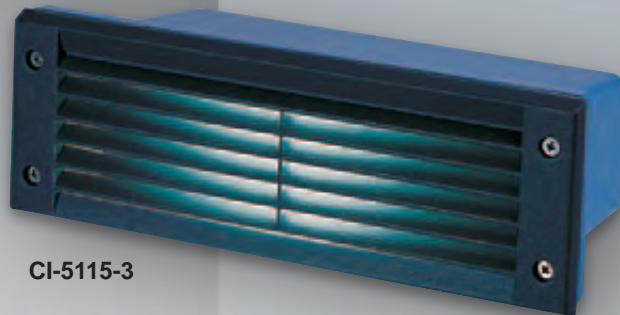

CI-5115-3

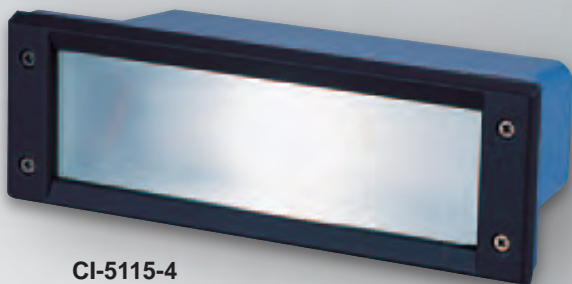

CI-5115-4

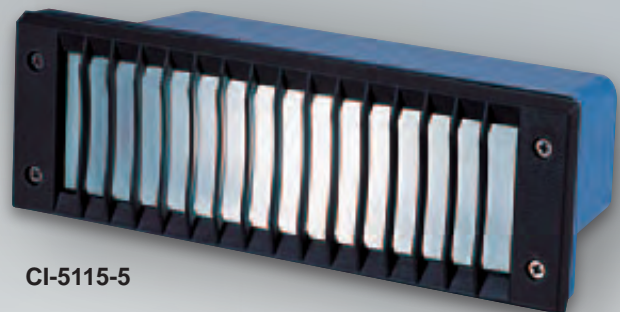

CI-5115-5

**CI-5115-3 2,250**

尺寸：L256mm W90mm H100mm  
 光源：LED 10Wx1  
 流明：1000lm  
 嵌入孔：255x90mm  
 材質：本體鋁壓鑄成型  
 粉體烤漆

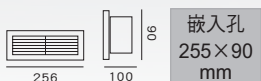

**CI-5115-4 2,250**

尺寸：L256mm W90mm H100mm  
 光源：LED 10Wx1  
 流明：1000lm  
 嵌入孔：255x90mm  
 材質：本體鋁壓鑄成型  
 粉體烤漆

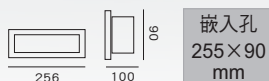

**CI-5115-5 2,250**

尺寸：L256mm W90mm H100mm  
 光源：LED 10Wx1  
 流明：1000lm  
 嵌入孔：255x90mm  
 材質：本體鋁壓鑄成型  
 粉體烤漆



outdoor BRACKET  
High efficiency high energy-saving



**CI-5116-1 2,310**

尺寸：L135mm W75mm D55mm  
光源：LED 12 PCS  
流明：300lm  
材質：本體鋁壓鑄成型  
粉體烤漆

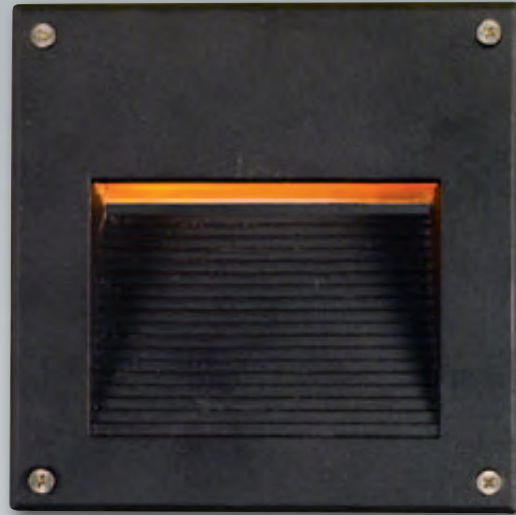
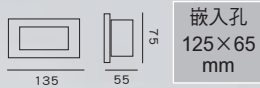

**CI-5116-2 2,050**

尺寸：L160mm W160mm D75mm  
光源：LED 1Wx3  
流明：300lm  
材質：本體鋁壓鑄成型  
粉體烤漆

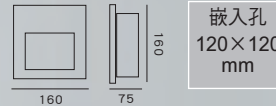

**CI-5116-3 1,710**

尺寸：L163mm W98mm D70mm  
光源：LED 1Wx3  
流明：300lm  
材質：本體鋁壓鑄成型  
粉體烤漆

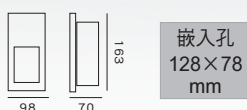

**CI-5116-4 1,710**

尺寸：L98mm W163mm D70mm  
光源：LED 1Wx3  
流明：300lm  
材質：本體鋁壓鑄成型  
粉體烤漆

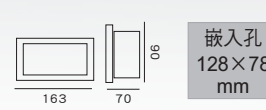

Slim & Flat  
**LED**



# 導光板使用 超薄型 LED 照明

DIY 裝設便利，簡易串接，低耗電長壽命



CI-5117-1 2,520

CI-5117-2 2,910

CI-5117-3 3,300

**ELPA LED 超薄層板燈 30cm(白光)**

裸裝尺寸：L300mm W30mm H8mm

**ELPA LED 超薄層板燈 30cm(黃光)**

裸裝尺寸：L300mm W30mm H8mm

**ELPA LED 超薄層板燈 60cm(白光)**

裸裝尺寸：L600mm W30mm H8mm

**ELPA LED 超薄層板燈 60cm(黃光)**

裸裝尺寸：L600mm W30mm H8mm

**ELPA LED 超薄層板燈 90cm(白光)**

裸裝尺寸：L900mm W30mm H8mm

**ELPA LED 超薄層板燈 90cm(黃光)**

裸裝尺寸：L900mm W30mm H8mm

# 超廣角



電池使用!

## ELPA 室內專用 玄關迎賓感應燈

電池壽命  
一日點亮 10 次 約可使用 10 個月



CI-5118-1 2,340

暮光系列 -LED 感應薄型玄關燈 - 珍珠白 / 黃光  
裸裝尺寸：L202mm W48mm H158mm  
規格：黃光 LED 四顆 2 號鹼性電池 (另售)



CI-5118-2 2,340

暮光系列 -LED 感應薄型玄關燈 - 灰棕色 / 白光  
裸裝尺寸：L202mm W48mm H158mm  
規格：黃光 LED 四顆 2 號鹼性電池 (另售)



室內專用 電池使用!  
玄關迎賓感應燈



CI-5118-3 2,340



CI-5118-4 2,340

暮光系列 -LED 感應壁掛玄關燈 - 珍珠白 / 黃光  
裸裝尺寸：L202mm W57mm H133mm  
規格：黃光 LED 四顆 2 號鹼性電池 (另售)

暮光系列 -LED 感應壁掛玄關燈 - 灰棕色 / 白光  
裸裝尺寸：L202mm W57mm H133mm  
規格：黃光 LED 四顆 2 號鹼性電池 (另售)



電池使用!

## 室內專用 感應式照明 兩段式切換

人體明暗感應壁掛式 LED 小夜燈 (白光)  
裸裝尺寸：L150.5mm W11mm H44mm  
規格：白光 LED 四顆 3 號 AA 鹼性電池 (另售)

CI-5118-5 1,560



暮光系列 -LED 感應玄關燈 (小圓)- 珍珠白 / 黃光  
裸裝尺寸：φ 85mm H148mm  
規格：黃光 LED 四顆 2 號鹼性電池 (另售)

暮光系列 -LED 感應玄關燈 (小圓)- 灰棕色 / 白光  
裸裝尺寸：φ 85mm H148mm  
規格：黃光 LED 四顆 2 號鹼性電池 (另售)



暮光系列 -LED 感應玄關燈 (小圓)- 珍珠白 / 黃光  
裸裝尺寸：φ 107mm H175mm  
規格：黃光 LED 四顆 2 號鹼性電池 (另售)

暮光系列 -LED 感應玄關燈 (小圓)- 灰棕色 / 白光  
裸裝尺寸：φ 107mm H175mm  
規格：黃光 LED 四顆 2 號鹼性電池 (另售)



電池壽命  
一日點亮 10 次 約可使用 12 個月  
(二號電池 × 4 另購)



和風造型人體明暗感應 LED 夜燈  
裸裝尺寸：L118mm W118mm H127mm  
規格：黃光 LED 四顆 2 號鹼性電池 (另售)

電池使用!

ELPA

# 櫥櫃型照明燈

## 開門自動點燈

最多可接續 8 個照明單體  
(三號電池 × 3 另購)



照明單體

照明控制主機

CI-5120-1 780



CI-5120-2 430



門窗開啟感應白光 LED 燈 (組合 / 電池式)

裸裝尺寸: L78mm W49mm H23mm  
規格: 白光 LED 三顆 3 號 AA 電池 (另售)

門窗開啟感應白光 LED 燈 (單品)

裸裝尺寸: L80mm W30mm H16mm  
規格: 白光 LED  
(需搭配 CI-5108-1 至多可串聯 8 個單品)



暮光系列 -LED 感應壁燈 (珍珠白 / 黃光)

裸裝尺寸: L66mm W25mm H12mm  
規格: 黃光 LED 三顆 3 號鹼性電池 (另售)

暮光系列 -LED 感應壁燈 (灰棕色 / 白光)

裸裝尺寸: L66mm W25mm H12mm  
規格: 黃光 LED 三顆 3 號鹼性電池 (另售)

電池使用!

# 防潮型 感應燈



CI-5120-3 1,680

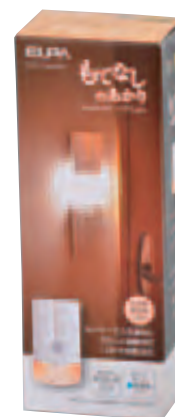

CI-5120-4 1,680



ELPA

每次點亮時間約 12 秒

電池壽命

一日點亮 10 次 約可使用 12 個月  
(三號電池 × 3 另購)

ELPA 室內專用

# 感應式 / 長時

# 電池使用! 兩用照明

電池壽命

一日點燈 10 回約可使用 10 個月

連續點燈約可使用 60 小時

(三號電池 × 3 另購)



CI-5120-5 1,660

CI-5120-6 1,660

CI-5120-7 1,660



鋁合金磁性方型感應夜燈 (紅色)

裸裝尺寸: L70mm W17mm H116mm  
規格: 白光 LED 三顆 3 號 AA 鹼性電池 (另售)

鋁合金磁性方型感應夜燈 (黑色)

裸裝尺寸: L70mm W17mm H116mm  
規格: 白光 LED 三顆 3 號 AA 鹼性電池 (另售)

鋁合金磁性方型感應夜燈 (藍色)

裸裝尺寸: L70mm W17mm H116mm  
規格: 白光 LED 三顆 3 號 AA 鹼性電池 (另售)



電池使用!

ELPA

# 感應式 / 長時 兩用照明

一日點燈 10 回 每次 20 秒  
約可使用 12 個月  
(四號電池 × 3 另購)

可置放可貼壁 (附雙麵膠)



人體明暗感應懸掛式圓形  
LED 小夜燈 (白光)

裸裝尺寸: L80mm W80mm H24mm  
規格: 白光 LED 三顆 4 號 AAA 鹼性電池 (另售)



CI-5121-1 880

電池使用!

ELPA

# LED 照明

連續點燈約可使用 60 小時  
(三號電池 × 3 另購)

可貼壁 (附雙麵膠)



按壓式方形  
LED 小夜燈 (白光)

裸裝尺寸: L90mm W90mm H21mm  
規格: 白光 LED 三顆 3 號 AA 鹼性電池 (另售)



CI-5121-2 780

# 室內專用 感應式 / 長時 兩用照明

ELPA

插電式

人體明暗感應長型 LED 小夜燈  
(暖白光)

裸裝尺寸: L110mm W60mm H50mm  
規格: 黃光 LED (插入插座即可使用)

人體明暗感應長型 LED 小夜燈  
(白光)

裸裝尺寸: L110mm W60mm H50mm  
規格: 白光 LED (插入插座即可使用)



暖白色



晝白色



CI-5121-3 1,170

ELPA 電池 / 交流兩用

# 感應式 / 長時 兩用照明

電池壽命

LED 單燈連續點燈約可使用 500 小時

LED 雙燈連續點燈約可使用 250 小時

(三號電池 × 3 另購)

可置放  
可掛式  
可手持



CI-5122-1 1,080

ELPA 充電式

# 感應式 / 長時 兩用照明

周圍環境變暗時自動點燈

可當作手電筒使用



CI-5122-2 1,370

ELPA 插電式

# 感應式 / 長時 兩用照明

周圍環境變暗時自動點燈



CI-5122-3 1,170

電池使用!

## ELPA 室內專用 感應式照明燈

一日點燈 10 回  
約可使用 4 個月  
(四號電池 × 3 另購)

人體 / 明暗感應櫥櫃燈 (電池式 / 白光)  
裸裝尺寸: L278mm W22mm H23mm  
規格: 黃光 LED 三顆 4 號 AAA 鹼性電池 (另售)



CI-5123-1 1,370

電池使用!

## ELPA 室內專用 櫥櫃照明燈 LED × 4 白光搭載

連續點燈約可使用 20 小時  
(四號電池 × 3 另購)

雙頭按壓式長型 LED 小夜燈 (電池式 / 白光)  
裸裝尺寸: L178mm W46mm H25mm  
規格: 白光 LED 三顆 4 號 AAA 鹼性電池 (另售)



CI-5123-2 590

電池使用!

## ELPA 室內專用 感應式 / 長時 兩用照明

感應模式一日點燈 10 回約可使用 8 個月  
連續點燈約可使用 40 小時  
(三號電池 × 3 另購)

人體明暗感應 LED 燈管小夜燈 (白光)  
裸裝尺寸: L41mm W40mm H176mm  
規格: 白光 LED 三顆 3 號 AA 鹼性電池 (另售)



CI-5123-3 880

### CI-5124-1

尺寸：L1000mm W20mm H30mm  
光源：訂製品  
材質：鋁製品 PC 罩

### CI-5124-3

尺寸：L1000mm W25mm H10mm  
光源：訂製品  
材質：鋁製品 PC 罩

### CI-5124-2

尺寸：L1000mm W25mm H10mm  
光源：訂製品  
材質：鋁製品 PC 罩

CI-5124-1

CI-5124-2

CI-5124-3

## 木頭裝橫嵌燈

### CI-5124-4

尺寸：L1000mm W40mm H250mm  
光源：訂製品  
材質：鋁製品 PC 罩

### CI-5124-6

尺寸：L1000mm W25mm H20mm  
光源：訂製品  
材質：鋁製品 PC 罩

### CI-5124-5

尺寸：L1000mm W25mm H20mm  
光源：訂製品  
材質：鋁製品 PC 罩

CI-5124-4

CI-5124-5

CI-5124-6

## 轉角燈

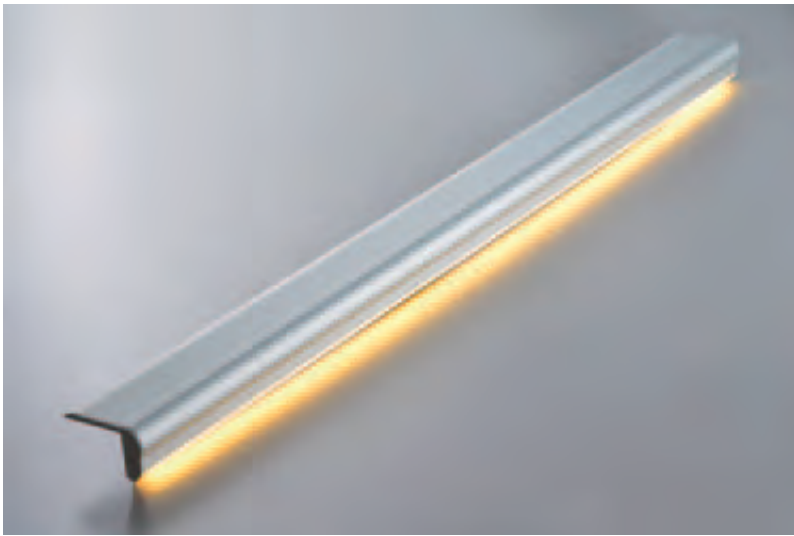

### CI-5125-1

尺寸：L1000mm H50mm  
光源：訂製品  
材質：鋁擠壓成型



### CI-5125-2

尺寸：L1000mm H40mm  
光源：訂製品  
材質：鋁擠壓成型



### CI-5125-3

尺寸：L1000mm W20mm H50mm  
光源：訂製品  
材質：鋁擠壓成型



### CI-5125-4

尺寸：L1000mm W20mm H30mm  
光源：訂製品  
材質：鋁擠壓成型



### 平台燈

### CI-5125-5

尺寸：L1000mm W20mm H30mm  
光源：訂製品  
材質：鋁製品 壓克力

## LED 規格

- 薄型鋁質燈條。
- 使用 SMD 3020 LED。
- 鋁質燈體與 LED 結合良好的散熱機能。
- 出光角度 120°
- 可供選擇顏色 :W / WW。

請來電詢價

型號	規格書	規格	LED	變壓器	電壓	尺寸	備註
CI-5126-1	SL-551-Q	18PCS/30cm	3528	另	DC:12V	L340mm W20mm	-
CI-5126-2	SL-551-Q	36PCS/30cm	3538	另	DC:12V	L340mm W20mm	-
CI-5126-3	SL-551-Q	9PCS/30cm	5050	另	DC:12V	L340mm W20mm	-
CI-5126-4	SL-551-Q	18PCS/30cm	5050	另	DC:12V	L340mm W20mm	-
CI-5126-5	SL-551-Q	9PCS/30cm	5050	另	DC:12V	L340mm W20mm	RGB
CI-5126-6	SL-551-Q	18PCS/30cm	5050	另	DC:12V	L340mm W20mm	RGB

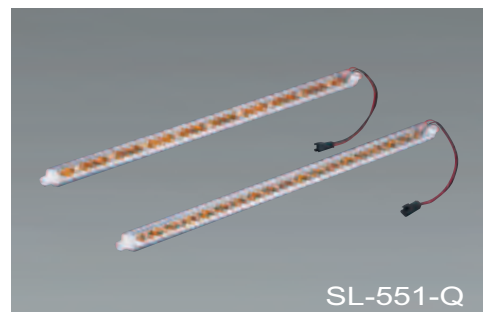

## LED 規格

- 薄型鋁質燈條。
- 使用 SMD 5050 LED。
- 鋁質燈體與 LED 結合良好的散熱機能。
- 出光角度 120°
- 可供選擇顏色 :RGB 變色。

請來電詢價

型號	規格書	規格	LED	變壓器	電壓	尺寸	備註
CI-5126-7	SL-551	3W	5050	另	DC:24V	L330mm W20mm	32.5cm
CI-5126-8	SL-551	6W	5050	另	DC:24V	L630mm W20mm	61.5cm
CI-5126-9	SL-551	9W	5050	另	DC:24V	L930mm W20mm	-
CI-5126-10	SL-551	12W	5050	另	DC:24V	L1230mm W20mm	119.5cm

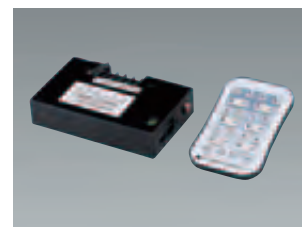
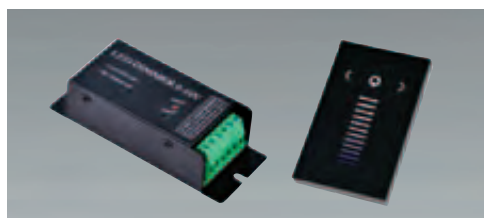
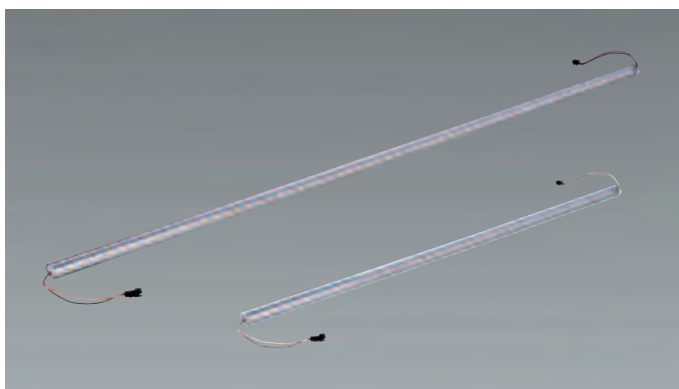
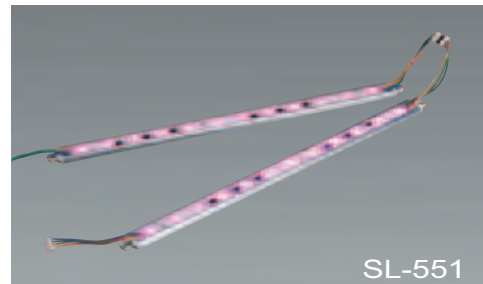

## SL-58X

- LED 軟版條燈系列。
- 使用 SMD 3528 或 5050 LED。
- 消耗功率：請參考規格書
- 可供選擇顏色 :R/G/B/Y/W/WW/RGB。
- 角度 110° -120°
- 流明：請參考規格書

型號	LED	規格	變壓器	電壓	尺寸	備註
CI-5126-11	SL-58X-3528-300	3528 300pcs	另	DC:12V	一捲 5M	軟版
CI-5126-12	SL-58X-3528-600	3528 600pcs	另	DC:12V	一捲 5M	軟版
CI-5126-13	SL-58X-3528-300-	3528 300pcs	另	DC:12V	一捲 5M	套管
CI-5126-14	SL-58X-3528-600-	3528 600pcs	另	DC:12V	一捲 5M	套管
CI-5126-15	SL-58X-3528-300-	3528 300pcs	另	DC:12V	一捲 5M	實心膠
CI-5126-16	SL-58X-5050-150	5050 150pcs	另	DC:12V	一捲 5M	軟版
CI-5126-17	SL-58X-5050-300	5050 300pcs	另	DC:12V	一捲 5M	軟版
CI-5126-18	SL-58X-5050-150-	5050 150pcs	另	DC:12V	一捲 5M	套管
CI-5126-19	SL-58X-5050-300-	5050 300pcs	另	DC:12V	一捲 5M	套管
CI-5126-20	SL-58X-5050-150-	5050 150pcs	另	DC:12V	一捲 5M	實心膠





CI-5127-1R 2,000



CI-5127-1Y 2,000



CI-5127-1W 2,000

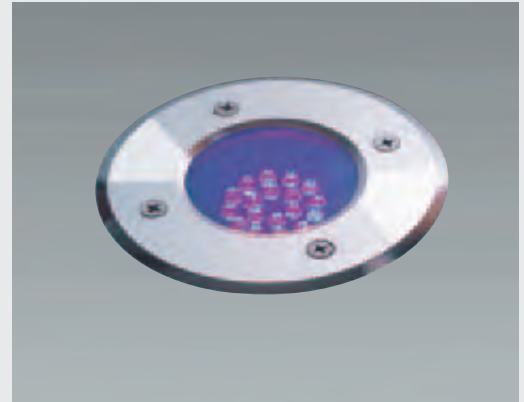

CI-5127-1B 2,000

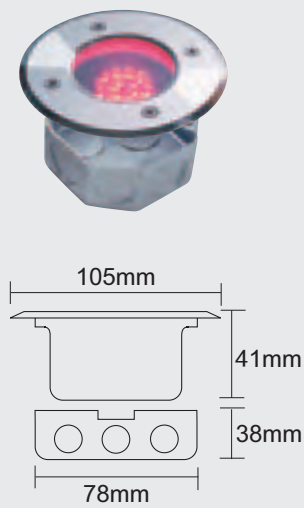

### LED 規格

- 使用 18 PCS 5mmLED。
- 地底燈相容於傳統八角配電盒。
- 內置變壓器 AC:90~220V 亮度一致
- 可供選擇顏色 :R/G/B/A/W/WW。

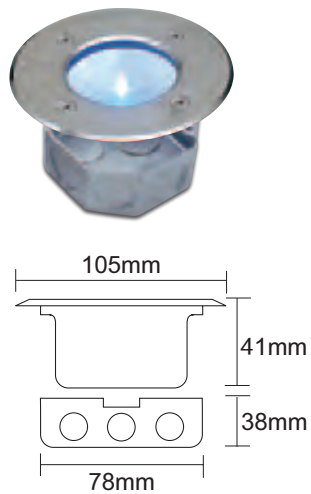

CI-5127-2 2,000  
CI-5127-3 2,000

### LED 規格

- 使用 1 PCS High Power LED。
- 地底燈相容於傳統八角配電盒。
- 電壓可選擇 AC/DC:12V 或 AC:90~220V 增加安全
- 可供選擇顏色 :R/G/B/A/W/WW。
- IP 參考值 :55。

型號	LED	規格	安規	變壓器	電壓	尺寸	備註
CI5127-1	SL-601	1.5W	CE	內置	AC:90~240V	W105mm H41mm	-
CI5127-2	SL-602	2.0W	CE	內置	AC:90~240V	W105mm H41mm	-
CI5127-3	SL-602	2.0W	CE	另	AC/DC:12V	W105mm H41mm	-

# 可控制類 LED 燈產品

## 圓形投射燈

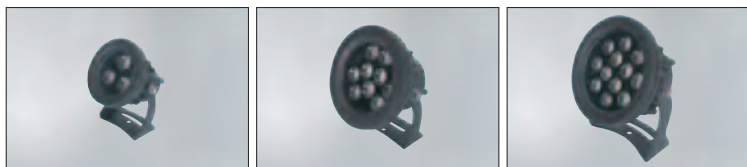

RL-3/9/12

RL-3T/9T/12T



BA-3

BT-1T



GD-6

GD-3T

## 水底燈

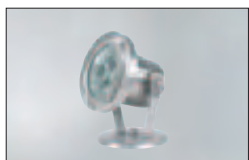

UD-3

UD-3T



UD-9

UD-6T

## 地底投射燈



IG-3/9/12



IG-3T/9T/12T

## 方形洗牆燈



WS-18/36/54

WS-12T/24T/36T



IG-3T/9T/12T

## 線性洗牆燈

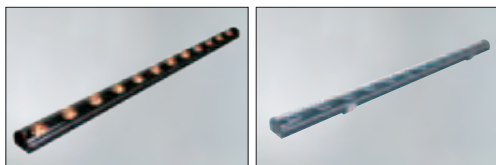

LT-6/12/18/24

LT-6T/12T

## 2835 軟條燈 鋁條燈 控色溫燈

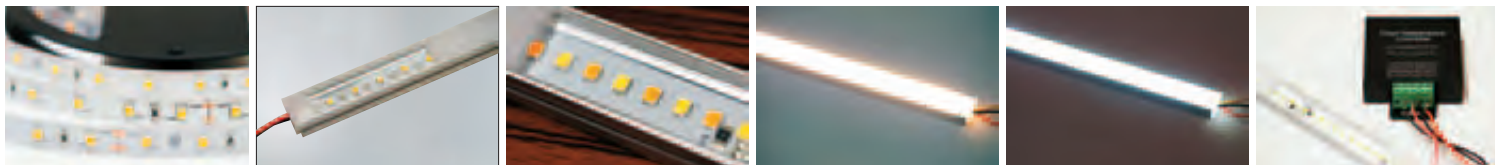

## 3528/5050 軟條燈

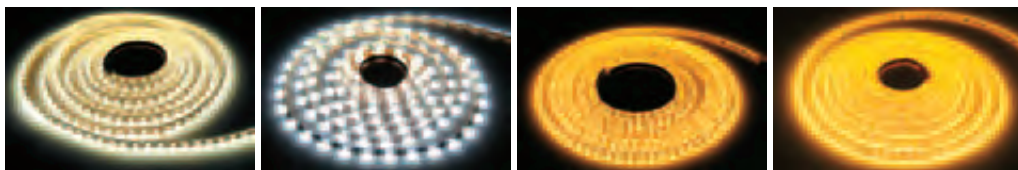



# 圓形投射燈 (接單式生產報價)

High efficiency high energy-saving



型號	尺寸 (mm)	LED	輸入電壓	消耗功率	色溫	重量 (Kg)
RL-3	Φ90 × 75 × 120	3	DC:12V	5W	3000K / 4000K / 6000K	0.6
RL-3AC	Φ90 × 75 × 120	3	DC:90-240V	5W	3000K / 4000K / 6000K	0.8
RL-9	Φ130 × 80 × 150	9	DC:12V	12W	3000K / 4000K / 6000K	1.1
RL-9AC	Φ130 × 80 × 150	9	DC:90-240V	12W	3000K / 4000K / 6000K	1.4
RL-12	Φ150 × 90 × 180	12	DC:12V	15W	3000K / 4000K / 6000K	1.4
RL-12AC	Φ150 × 90 × 180	12	DC:90-240V	15W	3000K / 4000K / 6000K	1.6
RL-3T	Φ90 × 75 × 120	3	DC:12V	9W	RGB 3 in 1	0.6
RL-6T	Φ130 × 80 × 150	6	DC:12V	18W	RGB 3 in 1	1.1
RL-9T	Φ150 × 90 × 180	9	DC:12V	27W	RGB 3 in 1	1.4

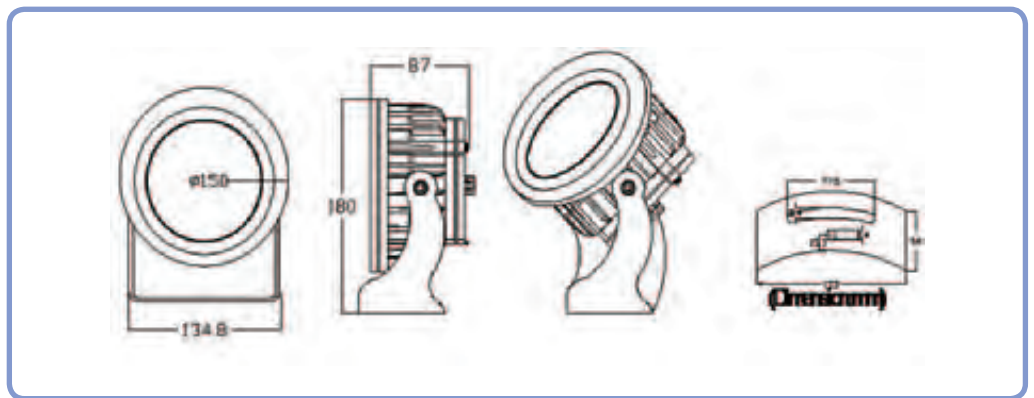
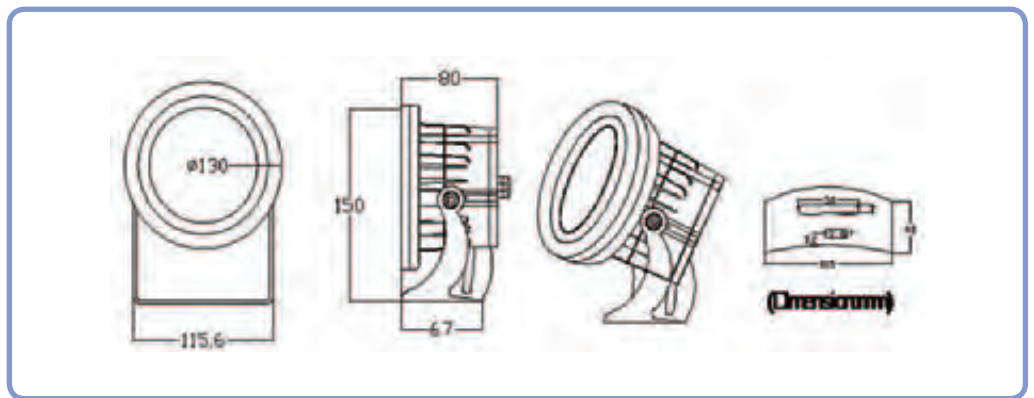
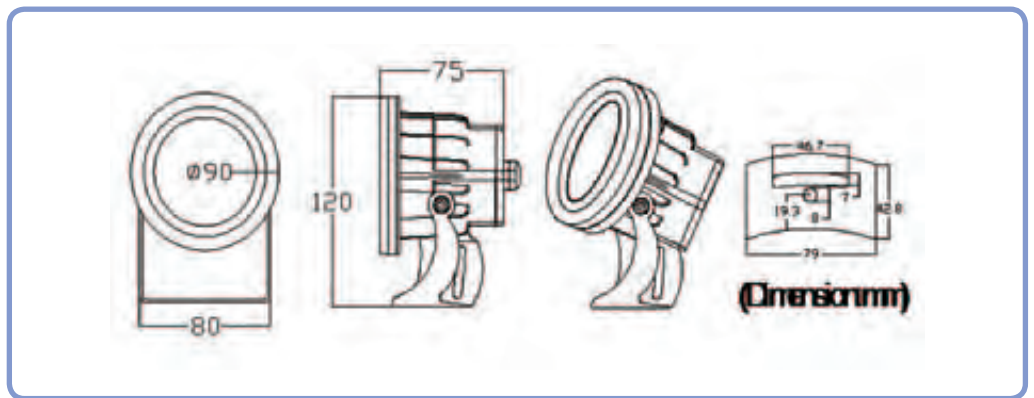

## 圓形投射燈 (接單式生產報價)

High efficiency high energy-saving



型號	尺寸 (mm)	LED	輸入電壓	消耗功率	色溫	重量 (Kg)
BA-3	Φ49 × 50 × 109.5	3	DC:12V	5W	3000K / 4000K / 6000K	0.3
BA-1T	Φ49 × 50 × 109.5	1	DC:5V	3W	RGB 3 in 1	0.3
GD-6	Φ88 × 50 × 148	6	DC:24V	10W	3000K / 4000K / 6000K	0.5
GD-3T	Φ88 × 50 × 148	3	DC:12V	10W	RGB 3 in 1	0.5

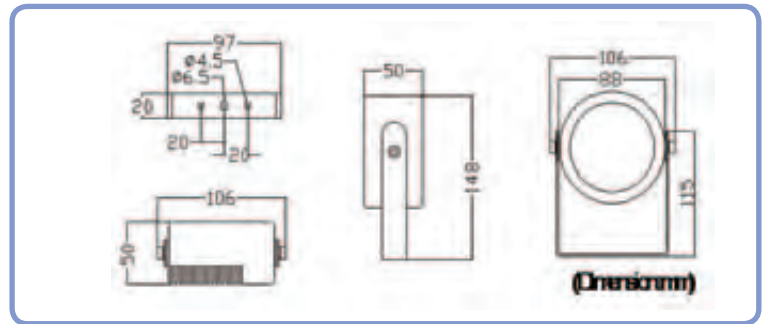
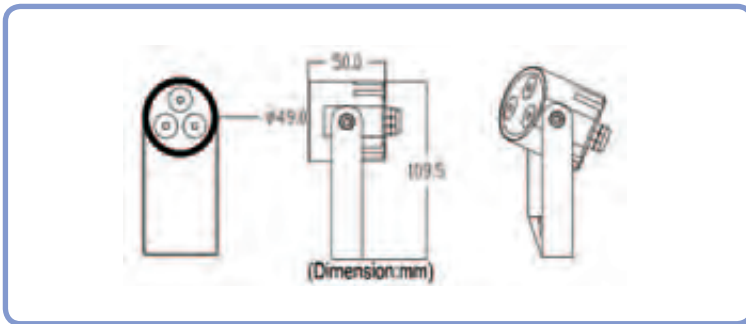

## 水底燈



型號	尺寸 (mm)	LED	輸入電壓	消耗功率	色溫	重量 (Kg)
UD-3	Φ98.5 × 130	3	DC:12V	5W	3000K / 4000K / 6000K	0.5
UD-3T	Φ98.5 × 130	3	DC:12V	9W	RGB 3 in 1	0.5
UD-9	Φ153 × 83 × 185	9	DC:12V	18W	3000K / 4000K / 6000K	1.5
UD-6T	Φ153 × 83 × 185	6	DC:12V	18W	RGB 3 in 1	1.5

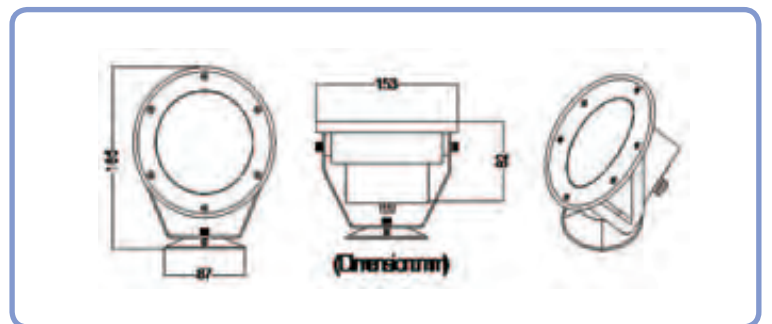
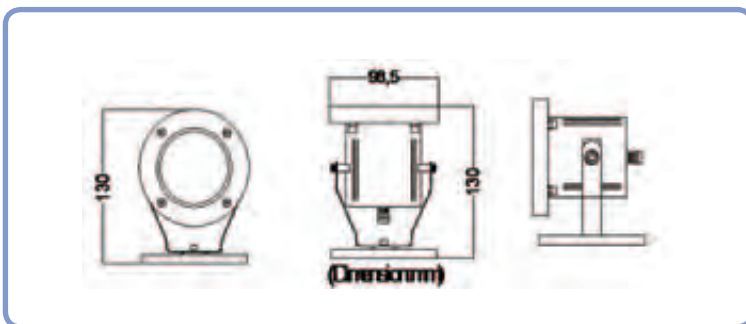

# 地底投射燈 (接單式生產報價)

High efficiency high energy-saving



CI-5131-1



CI-5131-2



CI-5131-3

型號	尺寸 (mm)	LED	輸入電壓	消耗功率	色溫	重量 (Kg)
IG-3	Φ110 × 70	3	DC:12V	5W	3000K / 4000K / 6000K	0.6
IG-3AC	Φ110 × 70	3	DC:90-240V	5W	3000K / 4000K / 6000K	0.8
IG-9	Φ150 × 73	9	DC:12V	15W	3000K / 4000K / 6000K	1.1
IG-9AC	Φ150 × 73	9	DC:90-240V	15W	3000K / 4000K / 6000K	1.4
IG-12	Φ170 × 74	12	DC:24V	18W	3000K / 4000K / 6000K	1.4
IG-12AC	Φ170 × 74	12	DC:90-240V	18W	3000K / 4000K / 6000K	1.7
IG-3T	Φ110 × 70	3×3W	DC:24V	9W	RGB 3 in 1	0.6
IG-6T	Φ150 × 73	6×3W	DC:24V	18W	RGB 3 in 1	1.1
IG-9T	Φ170 × 74	9×3W	DC:24V	27W	RGB 3 in 1	1.4



CI-5131-1

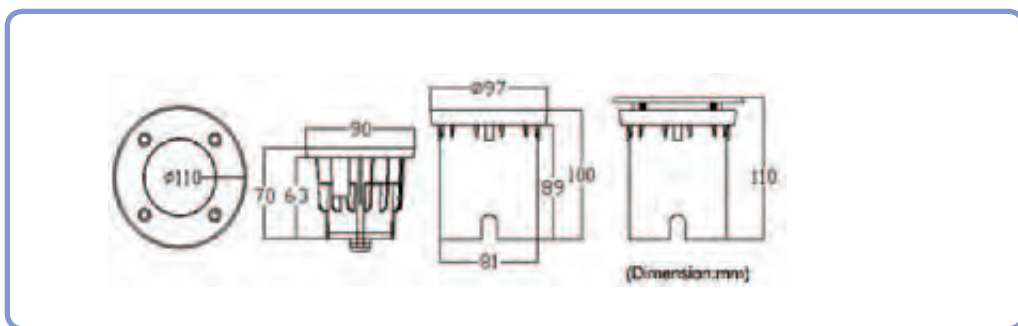

CI-5131-2

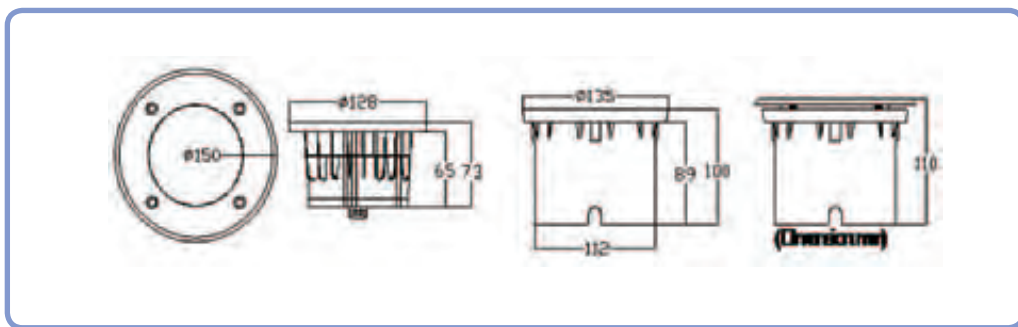

CI-5131-3

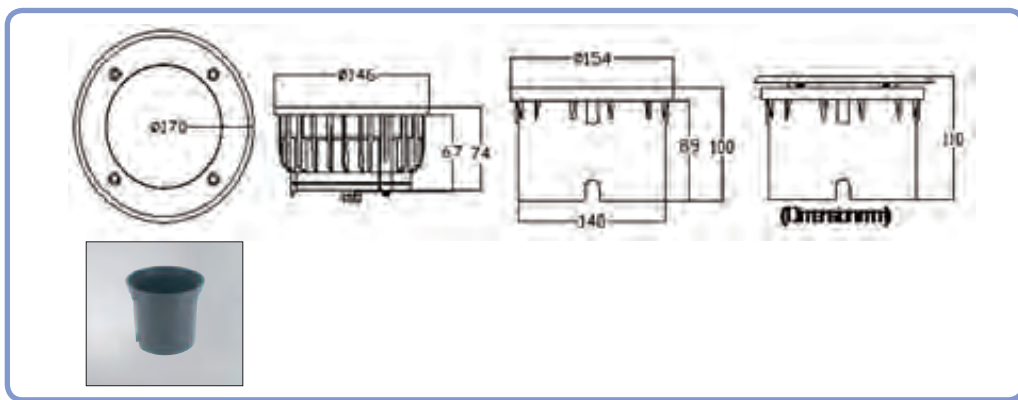

## 方形洗牆燈 (接單式生產報價)

High efficiency high energy-saving



型號	尺寸 (mm)	LED	輸入電壓	消耗功率	色溫	重量 (Kg)
WS-18	L187 W148 H166	18	DC:24V	25W	3000K / 4000K / 6000K	1.6
WS-18AC	L187 W148 H166	18	DC:90-240V	25W	3000K / 4000K / 6000K	2
WS-36	L322 W148 H166	36	DC:24V	50W	3000K / 4000K / 6000K	3.5
WS-36AC	L322 W148 H166	36	DC:90-240V	50W	3000K / 4000K / 6000K	4
WS-54	L455 W148 H166	54	DC:24V	75W	3000K / 4000K / 6000K	5
WS-54AC	L455 W148 H166	54	DC:90-240V	75W	3000K / 4000K / 6000K	5.5
WS-12T	L187 W148 H166	12×3W	DC:24V	36W	RGB 3 in 1	1.6
WS-24T	L322 W148 H166	24×3W	DC:24V	72W	RGB 3 in 1	3.5
WS-36T	L455 W148 H166	36×3W	DC:24V	108W	RGB 3 in 1	5



## 線性洗牆燈

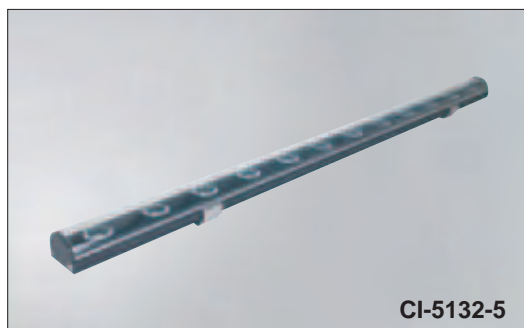

型號	尺寸 (mm)	LED	輸入電壓	消耗功率	色溫	重量 (Kg)
LT-6	L300 W33 H25	6	DC:24V	7W	3000K / 4000K / 6000K	0.2
LT-12	L600 W33 H25	12	DC:24V	15W	3000K / 4000K / 6000K	0.4
LT-18	L900 W33 H25	18	DC:24V	22W	3000K / 4000K / 6000K	0.6
LT-24	L1200 W33 H25	24	DC:24V	30W	3000K / 4000K / 6000K	0.8
LT-6T	L600 W33 H25	6	DC:24V	18W	RGB 3 in 1	0.4
LT-12T	L1200 W33 H25	12	DC:24V	36W	RGB 3 in 1	0.8



# 2835 軟條燈 鋁條燈 控色溫燈 (接單式生產報價)

High efficiency high energy-saving



型號	CL-T60-2835-XX-24V-5M	CL-48-2835-XX-60CM	CL-96-2835-XX-120CM
輸入電壓 (V)	DC:24V	DC:24V	DC:24V
消耗功率 (W)	14W/m (5m 60W)	9.6W	19.2W
色溫 (CT)	2700K / 3000K / 4000K / 6000K		
演色性 (CRI)	>82%		
光通量	1000lm/m	800lm/m	1600lm/m
燈數	2835×60pcs / m	48pcs 0.2W 2835	96pcs 0.2W 2835
	2835×300pcs / 5m		
長度	5m / 卷	L600 W18 H10 (mm)	L1200 W18 H10 (mm)
備註	裸板 or 套管	最長串接 4 米	

型號	CL48-2835-27 / 60-60CM	CL9696-2835-27 / 60-120CM
輸入電壓 (V)	DC:24V	
消耗功率 (W)	9.6W	19.2W
色溫 (CT)	2700K + 6000K 可調色溫	
演色性 (CRI)	>82%	
燈數	48pcs 2700K 2835	96pcs 2700K 2835
	48pcs 6000K 2835	96pcs 6000K 2835
長度	L600 W18 H10 (mm)	L1200 W18 H10 (mm)
備註	最長串接 4 米	

# 3528 /5050 軟條燈

High efficiency high energy-saving

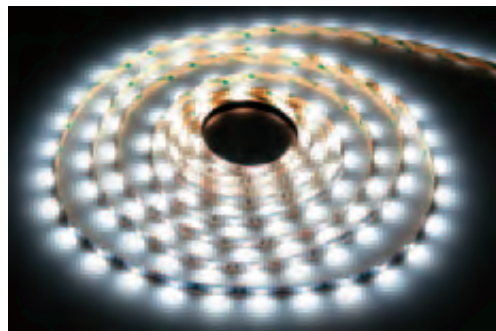
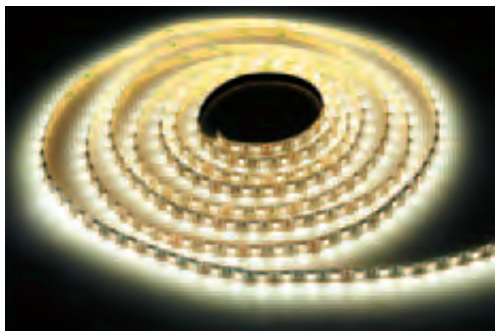

型號	CL-T30-5050-XX-12V-5M	CL-T60-5050-XX-12V-5M	CL-T30-5050-XX-12V-5M	CL-T60-5050-XX-12V-5M
輸入電壓 (V)	DC:12V			
消耗功率 (W)	7W/m 35W/5m	14W/m 60W/5m	7W/m 35W/5m	14W/m 60W/5m
色溫 (CT)	2700K / 3000K / 4000K / 6000K / R / G / B		RGB 三合一	
演色性 (CRI)	>74%			
燈數	150pcs / 5m	300pcs / 5m	150pcs / 5m	300pcs / 5m
長度	5m			
備註	裸板 ~ 不防水 套管 ~ 半防水 灌膠 ~ 防水			

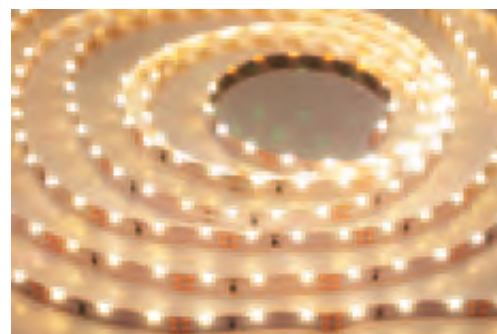
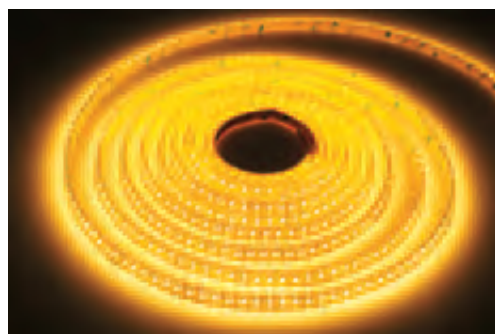
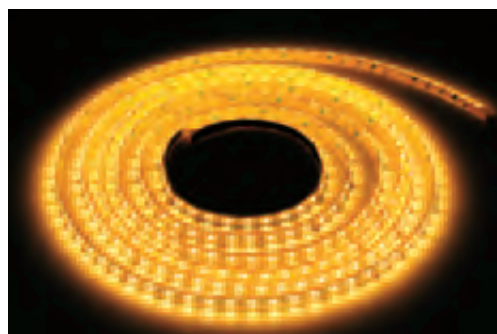

型號	CL-T60-3528-XX-12V-5M	CL-T120-3528-XX-12V-5M	CL-S60-335-XX-12V-5M
輸入電壓 (V)	DC:12V		
消耗功率 (W)	4.5W/m 22W/5m	9W/m 45W/5m	4.5W/m 22.5W/5m
色溫 (CT)	2700K / 3000K / 4000K / 6000K / R / G / B		
演色性 (CRI)	>74%		
燈數	300pcs / 5m	60pcs / 5m	3000pcs / 5m
長度	5m		
備註	裸板 ~ 不防水 套管 ~ 半防水 灌膠 ~ 防水		

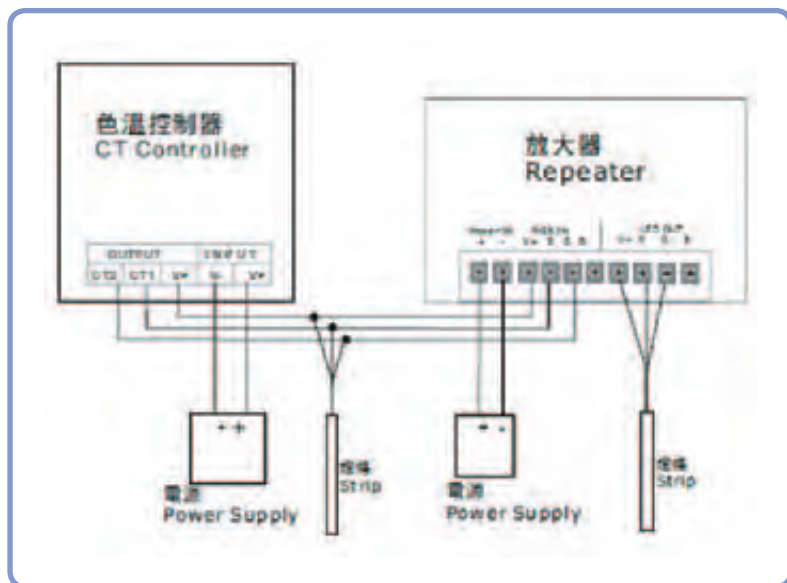



■ SL-865-O 1,125

- 規格：AR-111 15W LED 燈泡
- 消耗功率：15W
- LED: **OSRAM** Inside
- 輸入電壓：AC90-240V
- 輸出流明：1300lm
- 顏色：W/WW
- 演色性：CRI:84
- 出光角度：25° / 45°
- 工作壽命：30000 小時
- 材質：鋁鱗片
- 尺寸 (mm)：



■ SL-865-COB 1,500

- 規格：AR-111 COB 15W LED 燈泡
- 消耗功率：15W
- LED: **CREE** Inside
- 輸入電壓：AC90-240V
- 輸出流明：1300lm
- 顏色：W/WW
- 演色性：CRI:84
- 出光角度：25°
- 工作壽命：30000 小時
- 材質：鋁鱗片
- 尺寸 (mm)：



■ SL-866 1,125

- 規格：Par-30 15W LED 燈泡
- 消耗功率：15W
- LED: **OSRAM** Inside
- 輸入電壓：AC90-240V
- 輸出流明：1300lm
- 顏色：W/WW
- 演色性：CRI:84
- 出光角度：25° / 45°
- 工作壽命：30000 小時
- 材質：鋁鱗片
- 尺寸 (mm)：φ 95 × 105



■ SL-868-CREE 1,625

- 規格：Par-38 27W LED 燈泡
- 消耗功率：20W
- LED: **CREE** Inside
- 輸入電壓：AC90-240V
- 輸出流明：1800lm
- 顏色：W/WW
- 演色性：CRI:84
- 出光角度：25° / 45°
- 工作壽命：30000 小時
- 材質：鋁鱗片
- 尺寸 (mm)：φ 95 × 105



■ SL-212-A 375

- E14 蠟燭燈
- 消耗功率：6W
- LED: **OSRAM** Inside
- 輸入電壓：AC 90-240V
- 輸出流明：400lm
- 顏色：W/WW
- 演色性 CRI:84
- 出光角度：180°
- 工作壽命：30,000 小時
- 材質：鋁鱗片



■ SL-212B 375

- E14 蠟燭燈
- 消耗功率：6W
- LED: **OSRAM** Inside
- 輸入電壓：AC 90-240V
- 輸出流明：400lm
- 顏色：W/WW
- 演色性 CRI:84
- 出光角度：180°
- 工作壽命：30,000 小時
- 材質：鋁鱗片



■ SL-213S 375

- E14 蠟燭燈
- 消耗功率：6W
- LED: **OSRAM** Inside
- 輸入電壓：AC 90-240V
- 輸出流明：400lm
- 顏色：W/WW
- 演色性 CRI:84
- 出光角度：260°
- 工作壽命：30,000 小時
- 材質：鋁鱗片



■ SL-213-6W 350

- E27 燈泡
- 消耗功率：6W
- LED: **OSRAM** Inside
- 輸入電壓：AC 90-240V
- 輸出流明：400lm
- 顏色：W/WW
- 演色性 CRI:84
- 出光角度：180°
- 工作壽命：30,000 小時
- 材質：鋁



■ SL-711-10W 375

- 燈泡規格 :LED 球泡燈
- 消耗功率 :10W
- LED: 台製 LED
- 輸入電壓 :AC 90-240V
- 輸出流明 :900lm
- 顏色 :W/WW
- 演色性 CRI:84
- 出光角度 :260°
- 工作壽命 :30,000 小時
- 需使用於開放性空間
- 材質 : 鋁鱗片
- 尺寸 (mm): φ 65\*120



■ SL-711-8W 350

- 燈泡規格 :LED 球泡燈
- 消耗功率 :8W
- LED: 台製 LED
- 輸入電壓 :AC 90-240V
- 輸出流明 :500lm
- 顏色 :W/WW
- 演色性 CRI:84
- 出光角度 :260°
- 工作壽命 :30,000 小時
- 需使用於開放性空間
- 材質 : 鋁鱗片
- 尺寸 (mm): φ 65\*120



■ SL-710 375

- 燈泡規格 :LED 球泡燈
- 消耗功率 :10W
- LED: 台製 LED
- 輸入電壓 :AC 90-240V
- 輸出流明 :900lm
- 顏色 :W/WW
- 演色性 CRI:84
- 出光角度 :260°
- 工作壽命 :30,000 小時
- 需使用於開放性空間
- 材質 : 鋁鱗片
- 尺寸 (mm): φ 65\*120



■ SL-209-N 250

- 燈泡規格 :MR-16 投射燈
- 消耗功率 :6W
- LED: **NICHIA** Inside
- 輸入電壓 :AC/DC 12V
- 輸出流明 :400lm
- 顏色 :W/WW
- 演色性 CRI:84
- 出光角度 :25° 45°
- 工作壽命 :30,000 小時
- 需使用於開放性空間
- 材質 : 鋁鱗片
- 尺寸 (mm): φ 49\*41

■ SL-209-AC 375

- 燈泡規格 :AC MR-16 投射燈
- 消耗功率 :6W
- LED: **OSRAM** Inside
- 輸入電壓 :AC 90-240V
- 輸出流明 :400lm
- 顏色 :W/WW
- 演色性 CRI:84
- 出光角度 :25° 45°
- 工作壽命 :30,000 小時
- 需使用於開放性空間
- 材質 : 鋁鱗片
- 尺寸 (mm): φ 43\*41



■ SL-213-GU10 375

- 消耗功率 :6W
- LED: **OSRAM** Inside
- 輸入電壓 :AC 90-240V
- 輸出流明 :400lm
- 顏色 :W/WW
- 演色性 CRI:84
- 出光角度 :25° 45°
- 工作壽命 :30,000 小時
- 材質 : 鋁鱗片



■ SL-213-E27 375

- 消耗功率 :6W
- LED: **OSRAM** Inside
- 輸入電壓 :AC 90-240V
- 輸出流明 :400lm
- 顏色 :W/WW
- 演色性 CRI:84
- 出光角度 :25° 45°
- 工作壽命 :30,000 小時
- 材質 : 鋁鱗片



■ SL-813-O 625

- AR-111
- 消耗功率 :10W
- LED: **NICHIA** Inside
- 輸入電壓 :AC 90-240V
- 輸出流明 :700lm
- 顏色 :Color:W/WW
- 出光角度 :25° 45°
- 工作壽命 :30,000 小時
- 材質 : 鋁



■ SL-813-S 625

- AR-111
- 消耗功率 :10W
- LED: **NICHIA** Inside
- 輸入電壓 :AC 90-240V
- 輸出流明 :700lm
- 顏色 :W/WW
- 出光角度 :180°
- 工作壽命 :30,000 小時
- 材質 : 鋁





### SL-209-COB 6W

- 燈泡規格:MR-16 投射燈
- 消耗功率: 6W
- LED: **CREE** Inside
- 輸入電壓:AC/DC 12V
- 輸出流明:500lm
- 顏色:W/WW
- 演色性 CRI:84
- 出光角度:25°
- 工作壽命:30,000 小時
- 須使用於開放性空間
- 材質:鋁鱗片
- 尺寸(mm):49×41



### SL-209-COB 7W

- 燈泡規格:MR-16 投射燈
- 消耗功率: 7W
- LED: **CREE** Inside
- 輸入電壓:AC/DC 12V
- 輸出流明:600lm
- 顏色:W/WW
- 演色性 CRI:84
- 出光角度:25°
- 工作壽命:30,000 小時
- 須使用於開放性空間
- 材質:鋁鱗片
- 尺寸(mm):49×49.5



### SL-720

- 消耗功率:20W
- LED: **OSRAM** Inside
- 輸入電壓:AC 90-240V
- 輸出流明:2100lm
- 顏色:W/WW
- 演色性 CRI:84
- 出光角度:260°
- 工作壽命:30,000 小時
- 材質:鋁鱗片
- 尺寸(mm):94.8×180



### SL-721

- 消耗功率: 40W
- LED: **CREE** Inside
- 輸入電壓:AC 90-240V
- 輸出流明:4570lm
- 顏色:W/WW
- 演色性 CRI:84
- 出光角度:180°
- 工作壽命:30,000 小時
- 材質:鋁鱗片
- 尺寸(mm):130×188.7



### SL-722

- 消耗功率: 60W
- LED: **CREE** Inside
- 輸入電壓:AC 90-240V
- 輸出流明:5920lm
- 顏色:W/WW
- 演色性 CRI:84
- 出光角度:180°
- 工作壽命:30,000 小時
- 材質:鋁鱗片
- 尺寸(mm):203.7×287.3



### SL-723

- 消耗功率: 100W
- LED: **CREE** Inside
- 輸入電壓:AC 90-240V
- 輸出流明:7648lm
- 顏色:W/WW
- 演色性 CRI:84
- 出光角度:180°
- 工作壽命:30,000 小時
- 材質:鋁鱗片
- 尺寸(mm):203.7×331.7